



Electric Drives
and Controls

Hydraulics

Linear Motion and
Assembly Technologies

Pneumatics

Service

Rexroth
Bosch Group

Rexroth IndraMotion for Plastics – Automation system for injection molding machines

Intelligent, flexible and powerful

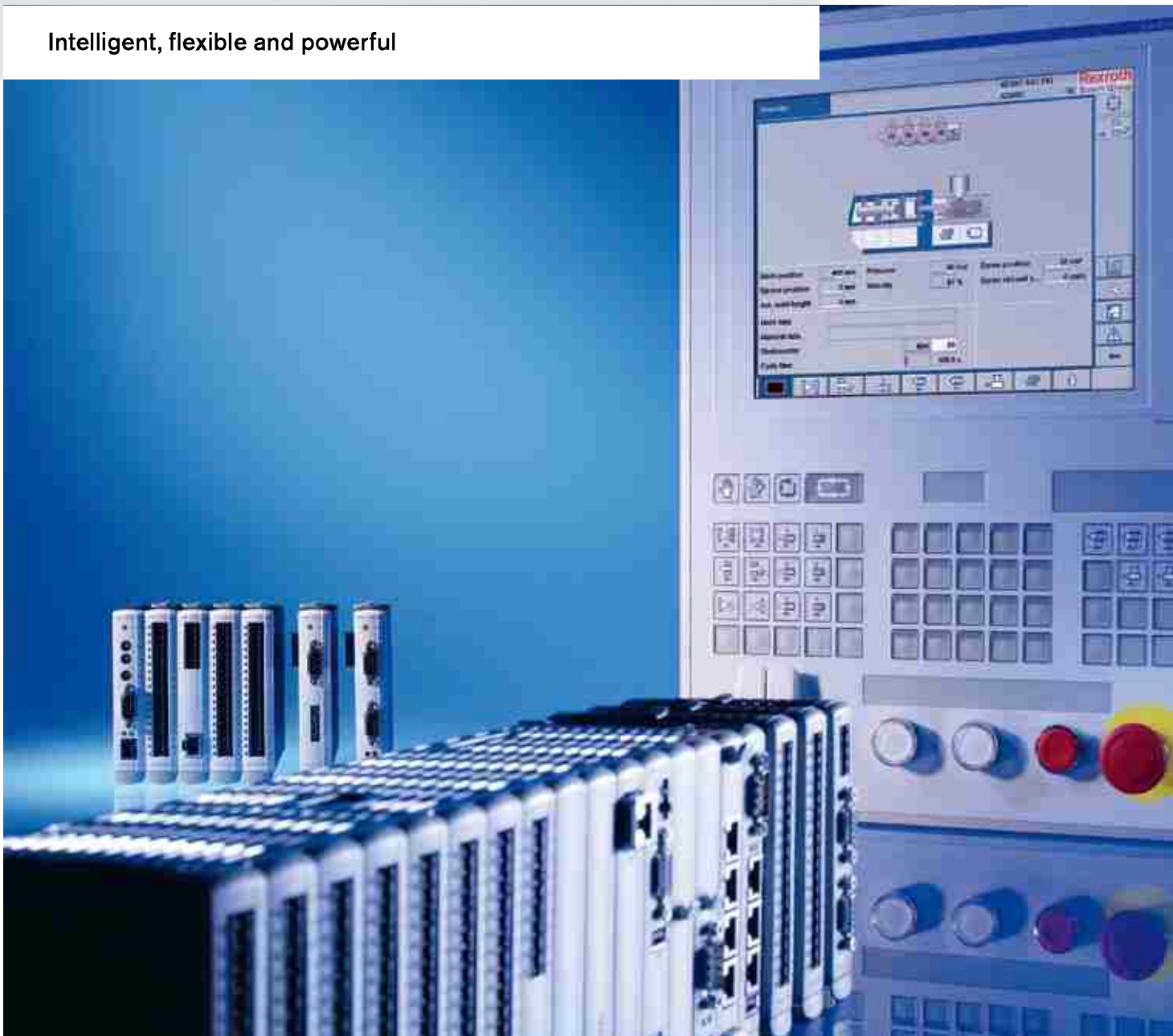



RODAVIGO, S.A.
RODAMIENTOS VIGO, S.A.

www.rodavigo.net

+34 986 288118
Servicio de Att. al Cliente



Contents

Bosch Rexroth AG dominates in all relevant drive, control and motion technologies worldwide. We offer that vitally important added value in electric drive and control systems – regardless of where you are located and what you want to automate!



Automation expertise	01
Automation system	02
IndraMotion for Plastics compact – description of the system	2.1
IndraMotion for Plastics universal – description of the system	2.2
IndraMotion for Plastics performance – description of the system	2.3
IndraMotion for Plastics – comparison of the systems	2.4
Control components	03
Control application and engineering tools	3.1
Visualization	3.2
Operator terminals	3.3
Control units	3.4
Option modules	3.5
Expansion modules	3.6
Accessories	3.7
Glossary	04
More information: www.boschrexroth.com/plastics	



Our goal: To be world market leader in providing benefits to customers

With our broad portfolio of products and services we are geared to responding swiftly and flexibly to all your requirements – starting from development and production, right through to sales and service. Working in co-operation with you, the customer, we will offer the perfect solution for every application. Our products, combined with our high level of consulting expertise, will give you the competitive advantage while minimizing your technical and financial outlay. And what's more, proximity to our customers worldwide enables us to meet exacting quality requirements at any time and anywhere, thus maximizing the benefits of our products.

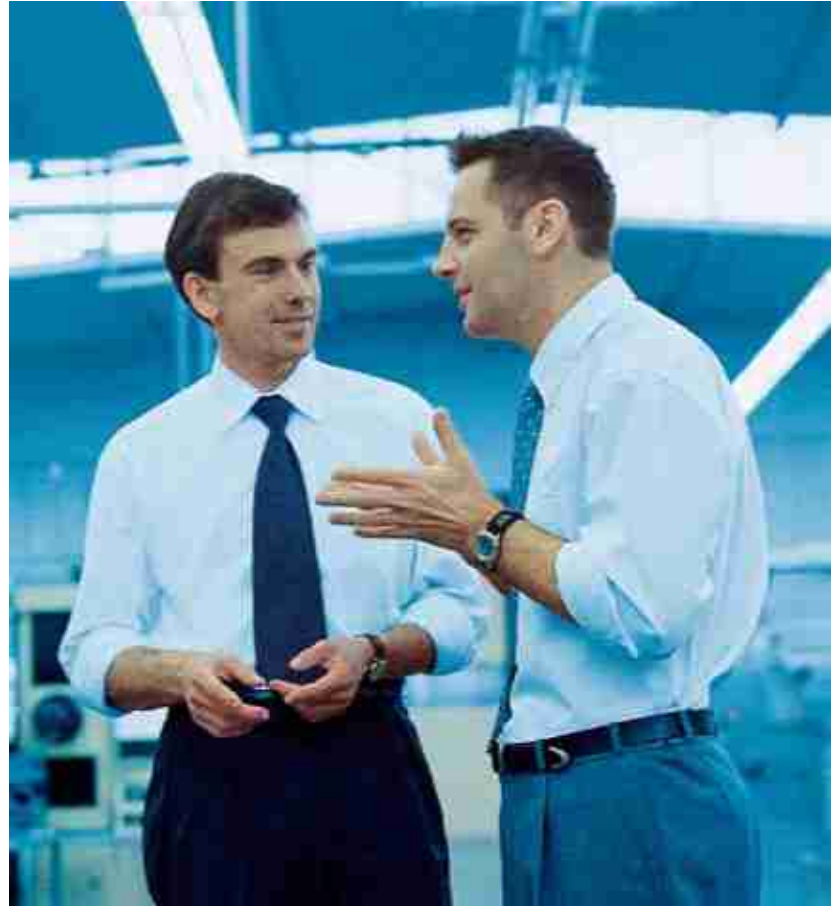

Rexroth is unique. No other brand on the world market can offer its customers all type of drive and control technologies, both on a specialized and integrated basis. We are considered to be the worldwide benchmark when it comes to drives, controls and motion. Our technological leadership is continually offering us the opportunity for new challenges, with approximately 35,300 employees in more than 80 countries around the world. This is possible thanks to an infrastructure designed with partnership and customer

proximity in mind. As a company Bosch Rexroth can look back on more than 200 years of tradition. As a wholly-owned subsidiary of Robert Bosch GmbH we are part of a globally-operating technology group. All this is both our drive and our commitment. And it's unique – just like Bosch Rexroth. The Drive & Control Company.

Everything you need for drive, control and motion:

- Electric Drives and Controls
- Industrial Hydraulics
- Mobile Hydraulics
- Linear Technology
- Assembly
- Pneumatics



Experience in innovations



The Applications Center for Plastic Processing Machines contains Rexroth's expertise in all control and drive technologies, its global applications experience, and its profound understanding of the requirements for the automation of injection molding machines. This is where our industry specialists develop the optimum automation solution for every injection molding task. The spectrum ranges from special controls with a maximum of functionality, through configurable hydraulic components and electric drives, to cross-technology system solutions. Constant discussion with the industry, allows the Applications Center to initiate special development projects for the automation of injection molding machines and continuously advances the state of the art with its innovations. Rexroth works in close partnership with machine manufacturers on tailor-made automation solutions which are

tested at an early stage using the most modern simulation software. Delivering top-quality turn-key solutions allows for shorter assembly and commissioning time and reduces the costs of manufacturing. Through its world-wide presence in more than 80 countries, Rexroth can bring this expertise into play at every point of the globe. While provide the manufacturers of injection molding machines with extensive services to help them face global competition.

Be it tailor-made automation solutions for newly developed injection molding machine concepts, reliable partnership in series manufacturing, or world-wide service: with its globally acquired know-how as a competent automation partner Rexroth accompanies the manufacturers of injection molding machines over the entire life-cycle of their machines.





IndraMotion for Plastics – a scalable automation system for injection molding machines

IndraMotion for Plastics is the system solution from Rexroth for the automation of modern injection molding machines – regardless of whether they are equipped with hydraulic, electric, or hybrid drives. A ready-made basic application, comprehensive engineering tools, and user-friendly visualization functions simplify the application, and accelerate the commissioning of different machine types. Powerful control units, high-speed I/O ports and real-time field buses round out the system and contribute to ensuring perfect, reproducible results.

Regardless of whether you want to automate a standard hydraulic injection molding machine or a high-speed system with distributed I/O and electric drives, IndraMotion for Plastics ensures an injection molding process with the highest dynamics and precision for all applications.

The following system categories are available to choose from:

- IndraMotion for Plastics compact – for hydraulic injection molding machines
- IndraMotion for Plastics universal – for injection molding machines with electric or hybrid drive technology
- IndraMotion for Plastics performance – for high-end machines with the most exacting demands on data processing and I/O integration

Both the hardware and the software have a modular design, allowing optimum integration of Indra-Motion for Plastics in a wide range of machine concepts. This guarantees maximum efficiency and flexibility for:

- standard injection molding machines
- high-speed machines
- multi-component machines
- machines with distributed I/O integration
- machines with integrated work-piece handling





IndraMotion for Plastics is convincing

No matter what expectations you have of the automation system for your injection molding machine – IndraMotion for Plastics will convince you through

- ▄ flexible scalability for all machine types
- ▄ high-performance application framework
- ▄ highest control and process standards

Your benefit

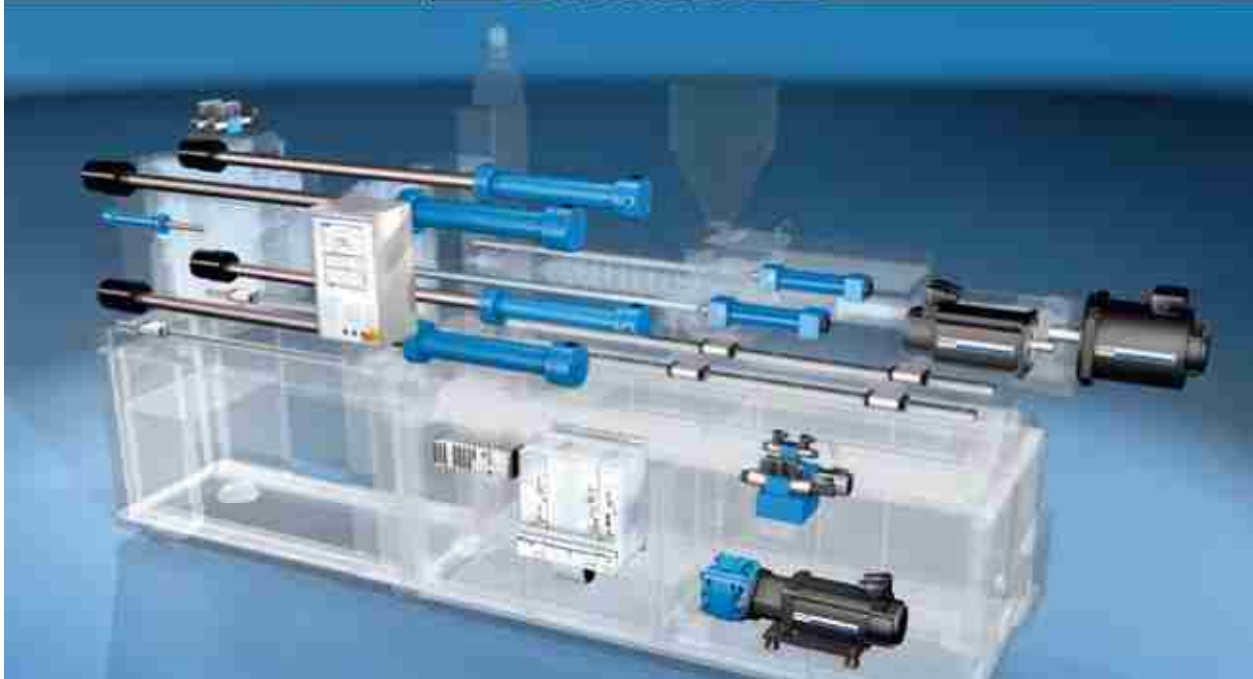

The benefits for you:

- modular system design for maximum flexibility
- individually scalable in power and functionality
- central and distributed control architectures
- powerful control units for the highest control and process standards
- user-friendly operator terminals with robust membrane key-boards and modern touchscreen technology
- wide portfolio of I/O modules and option modules
- user-friendly engineering tools
- ready-made basic application for standard injection molding machines
- defined technology functions for easy adaptation to the application
- IEC-compliant PLC programming
- user masks designed for flexible configuration
- many different internationally recognized communications standards
- simple connection to higher-level ERP systems





Automation system – IndraMotion for Plastics





IndraMotion for Plastics compact – description of the system

12
2.1

IndraMotion for Plastics universal – description of the system

14
2.2

IndraMotion for Plastics performance – description of the system

16
2.3



IndraMotion for Plastics – comparison of the systems

18
2.4



System overview

IndraMotion for Plastics is notable for its software and hardware components that are designed specifically for injection molding

Automation system		IndraMotion for Plastics		
Controller series		compact	universal	performance
				
Operation/ Visualization	Operation	Membrane keyboard	Touchscreen/membrane keyboard	
	Creation of user masks	PLC program	Java-based, can be graphically designed	
	Layout of user masks	Fixed format with standard user elements	Scalable format with graphic user elements	
Controller	Controller type	Compact	Modular	
	I/O expansion	Distributed through CAN	Local, distributed through CAN	Local, distributed through CAN or K-Net
	"plus" variant	Yes	Yes	-
	Runtime system	IEC 61131-3		
Application	Machine type	Hydraulic machines	Hydraulic, fully electric and hybrid machines	High-speed system, multi-component machine
	Integration handling automation	-	-	Yes
	Closed-loop injection process	Yes		



Selection guide

With the following selection guide you can determine which "IndraMotion for Plastics" system version best matches a particular type of machine.

Machine type	Drive technology		System features				IndraMotion for Plastics – system version
	Hydraulic	Fully electric, hybrid	Touchscreen	Additional I/O	Additional distributed I/O	Additional distributed high-speed I/O	
Standard machine	●						▶ compact
	●				●		▶ compact plus
	●		●	●	●		▶ universal
	●	●	●	●	●		▶ universal plus
High-speed machine							▶ performance
Multi-component machine							
Machine with distributed, real-time-capable I/O integration	●	●	●	●	●	●	
Integrated handling automation							



IndraMotion for Plastics compact

IndraMotion for Plastics compact is optimized for the cost-effective automation of standard injection molding machines with hydraulic drive technology. Compact components and specially developed software functions enable the injection molding application to be implemented quickly and economically.

The basic system

A control unit and an operator terminal form the basic system include all functions that are required for the efficient automation of injection molding machines. Also integrated are an intelligent PLC runtime system, extensive technology functions, tailor-made process visualization and all necessary hardware interfaces for simple connection to the process and peripherals.

The control unit

A high-performance 32-bit processor coordinates all the control and visualization tasks. On-board inputs and outputs for connecting the sensors and actuators mean that no additional I/O ports are required. Numerous interfaces enable the integration of external peripherals such as printers or temperature sensors. Connection to the higher level network takes place through Ethernet. In combination with an optional OPC server it is an easy matter to link up with a higher host computer level.

The operator terminal

The operator terminals are designed specially for standard injection molding machines and are available as 8" or 10" TFT displays. Predefined membrane key-boards enable quick and direct access to machine functions. Ready-to-use standard user masks are easy to adapt to special control applications and to extend for specific machines.

IndraMotion for Plastics compact plus

The "compact plus" version provides additional I/O ports on the control unit for the connection of sensors and actuators. Optional expansion modules are available through the integrated CAN interface for distributed use.

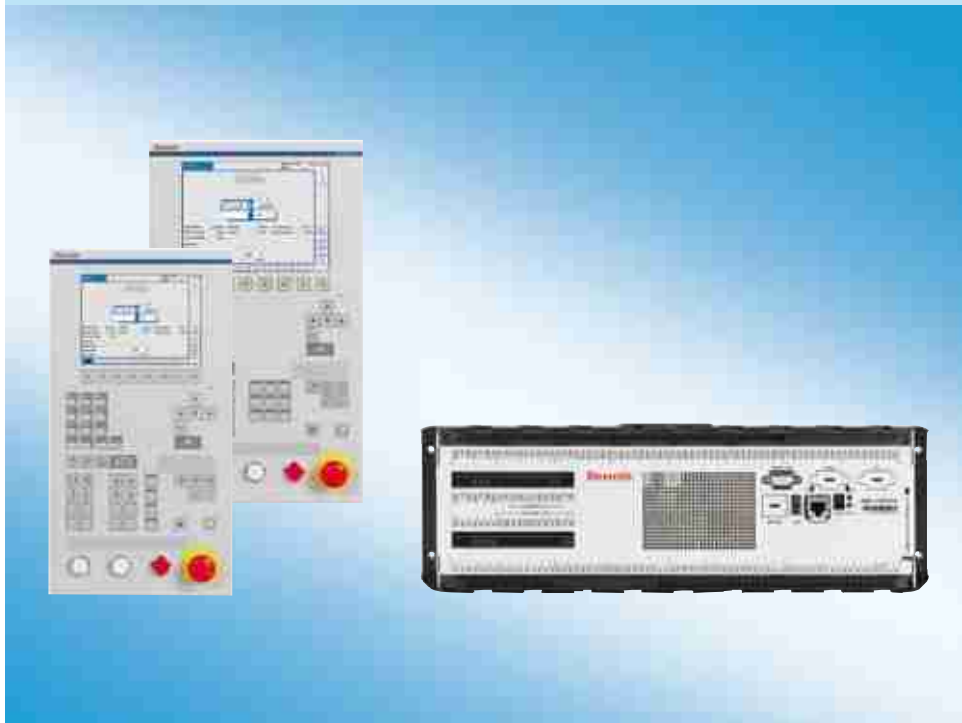



IndraMotion for Plastics compact

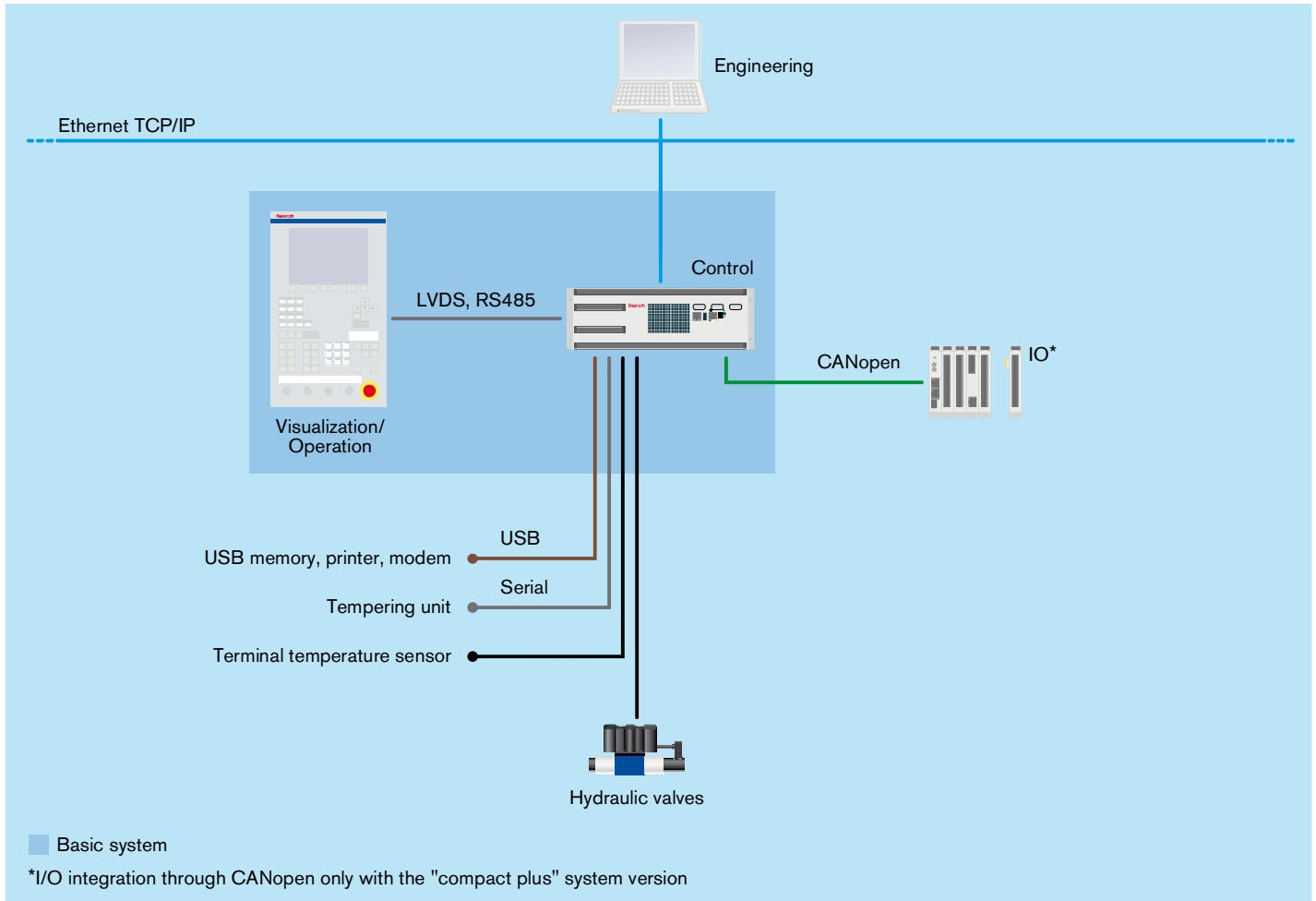

13
2.1
IndraMotion for Plastics compact – description of the system

More information in the catalog	
IndraMotion for Plastics – comparison of the systems	Chapter 2.4
Control application and engineering tools	Chapter 3.1
Visualization	Chapter 3.2
Operator terminals	Chapter 3.3
Control units	Chapter 3.4
Expansion modules	Chapter 3.6
Accessories	Chapter 3.7
More information on the Internet at www.boschrexroth.de/mediadirectory	
Hydraulic drive technology	Product catalog "Hydraulic pumps and motors"/Document: RE00112-01
	Product catalog "Switching valves-Isolator, directional, pressure and flow valves"/Document: RE00112-02
	Product catalog "Servo proportional and high-response valves-Directional, pressure and flow valves"/Document: RE00112-03

IndraMotion for Plastics universal

IndraMotion for Plastics universal is the modular series for the automation of hydraulic, electric or hybrid injection molding machines where process quality and user-friendly operation are paramount. An easy-to-modify basic application is available for implementing hydraulic machines. With additional technology functions you can also automate electric drive and hybrid applications simply and quickly.

The basic system

A modular control unit and a touchscreen operator terminal form the "universal" basic system. The combination of this platform with industry-specific technology functions and powerful process visualization provides the basis for comprehensive machine automation.

The control unit

The control units of the "IndraMotion for Plastics universal" systems are based on Intel Celeron processors and are modular in design. Touchscreen visualization uses Java technology which runs with the integrated Java runtime system. There are numerous I/O ports on board for process interfacing. Should modular expansions and adaptation to a special machine type be necessary, expansion modules are simply connected end-to-end to the controller or integrated through the CAN interface. Communication to a higher level network takes place through Ethernet, and peripherals such as printers are linked up through the USB interface.

The operator terminal

For easy operation, the fully graphics-capable 8" and 12" terminals are equipped with membrane keyboards and touchscreen technology – this means maximum flexibility for the visualization of different machine types. The visualization of standard hydraulic injection molding machines is possible with the ready-made Java user masks of the basic application. Those can be modified quickly and easily to create customer-specific interfaces.

IndraMotion for Plastics universal plus

The "universal plus" system meets demands for more computer power in the medium performance range. It is used for the automation of injection molding machines with electric or hybrid drive technology. Control communication with the electric drive takes place through the SERCOS III option module. Drive integration through a SERCOS 2 expansion module is possible as an alternative.





IndraMotion for Plastics universal

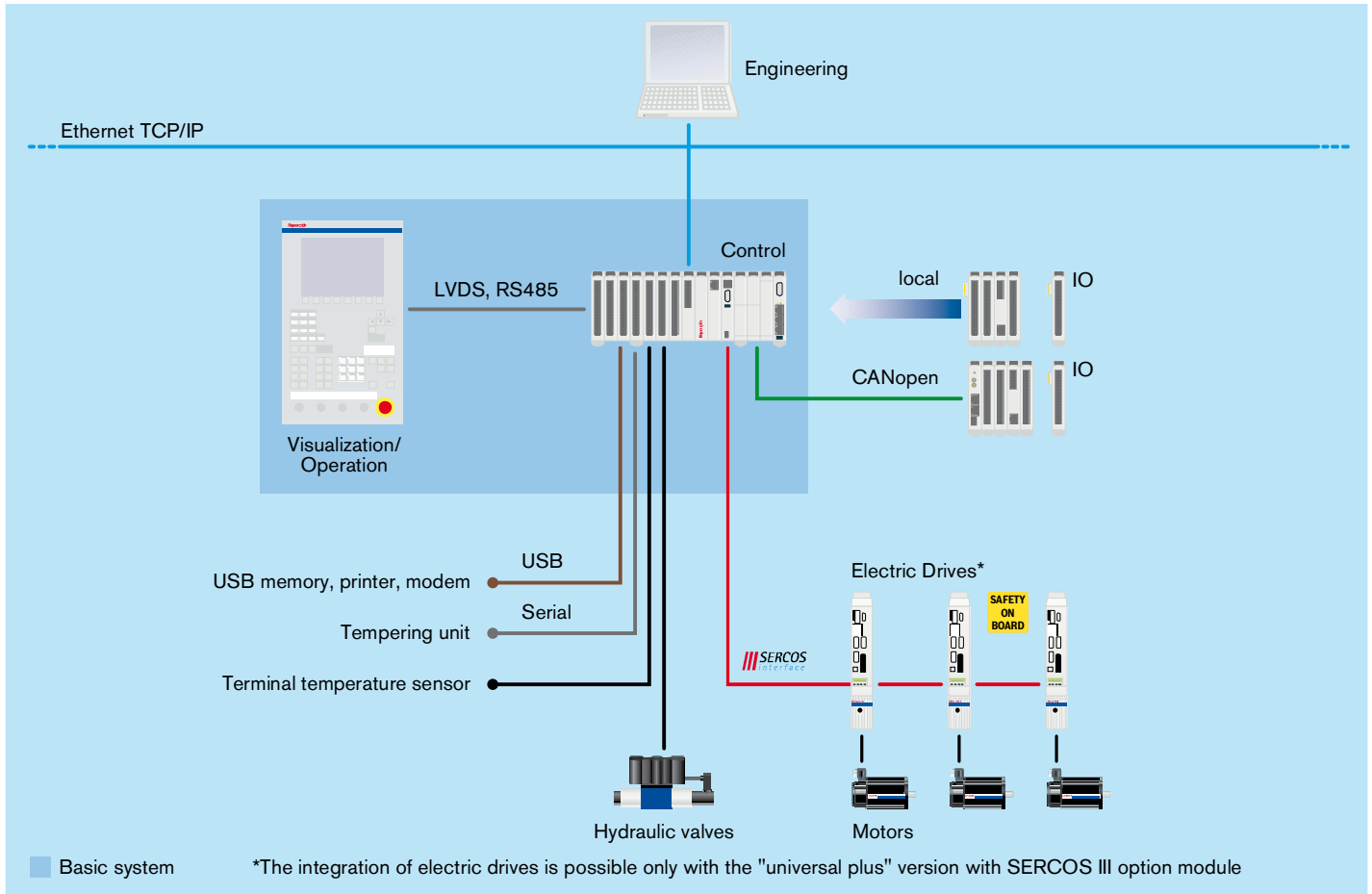

More information in the catalog

IndraMotion for Plastics – comparison of the systems	Chapter 2.4
Control application and engineering tools	Chapter 3.1
Visualization	Chapter 3.2
Operator terminals	Chapter 3.3
Control units	Chapter 3.4
Option module	Chapter 3.5
Expansion modules	Chapter 3.6
Accessories	Chapter 3.7

More information on the Internet at www.boschrexroth.de/mediadirectory

Electric drive technology	Product catalog "Drive System Rexroth IndraDrive"/Document: 71511
	Product catalog "Hydraulic pumps and motors"/Document: RE00112-01
Hydraulic drive technology	Product catalog "Switching valves-Isolator, directional, pressure and flow valves"/Document: RE00112-02
	Product catalog "Servo proportional and high-response valves-Directional, pressure and flow valves"/Document: RE00112-03



IndraMotion for Plastics performance

IndraMotion for Plastics performance is the most powerful series and rounds off IndraMotion for Plastics at the top end of the range. Its powerful control unit, modular design and almost unlimited consistent scalability make it perfect for all applications requiring complex machine functions and the highest control standards, e.g. multi-component machines, high-speed systems, fully electric injection molding machines, lines with integrated handling automation, and machines with distributed sensor/actuator connections.

The basic system

The "performance" series unites the flexibility of IndraMotion for Plastics universal with high-end standards of control technology and visualization. The powerful control unit ensures the highest standard of control for the process, and the operator terminal with its large touchscreen display supports ergonomic operation and clear-cut visualization.

The control unit

A powerful Intel Celeron M processor meets all the requirements for the computer performance, and together with integrated logic functions it enables changeover during the injection process to take place with an accuracy in the 100 μ s range. The control unit is equipped with K-Net, an Ethernet-based high-speed real-time bus. K-Net was developed specially to meet demands for minimum reaction times during injection molding. Needless to say, the needs of many different machine types can be met through central adaptation of the control unit using end-to-end expansion modules.

The operator terminal

The high-grade TFT touchscreen displays of the "performance" version are available in 12" horizontal format and 15" vertical format. An advantage of the vertical format is that it allows more information to be visualized in the same mounting width. Also, the operator terminals are equipped with USB interfaces for connecting peripherals, and with an RFID module for contactless user identification.





IndraMotion for Plastics performance

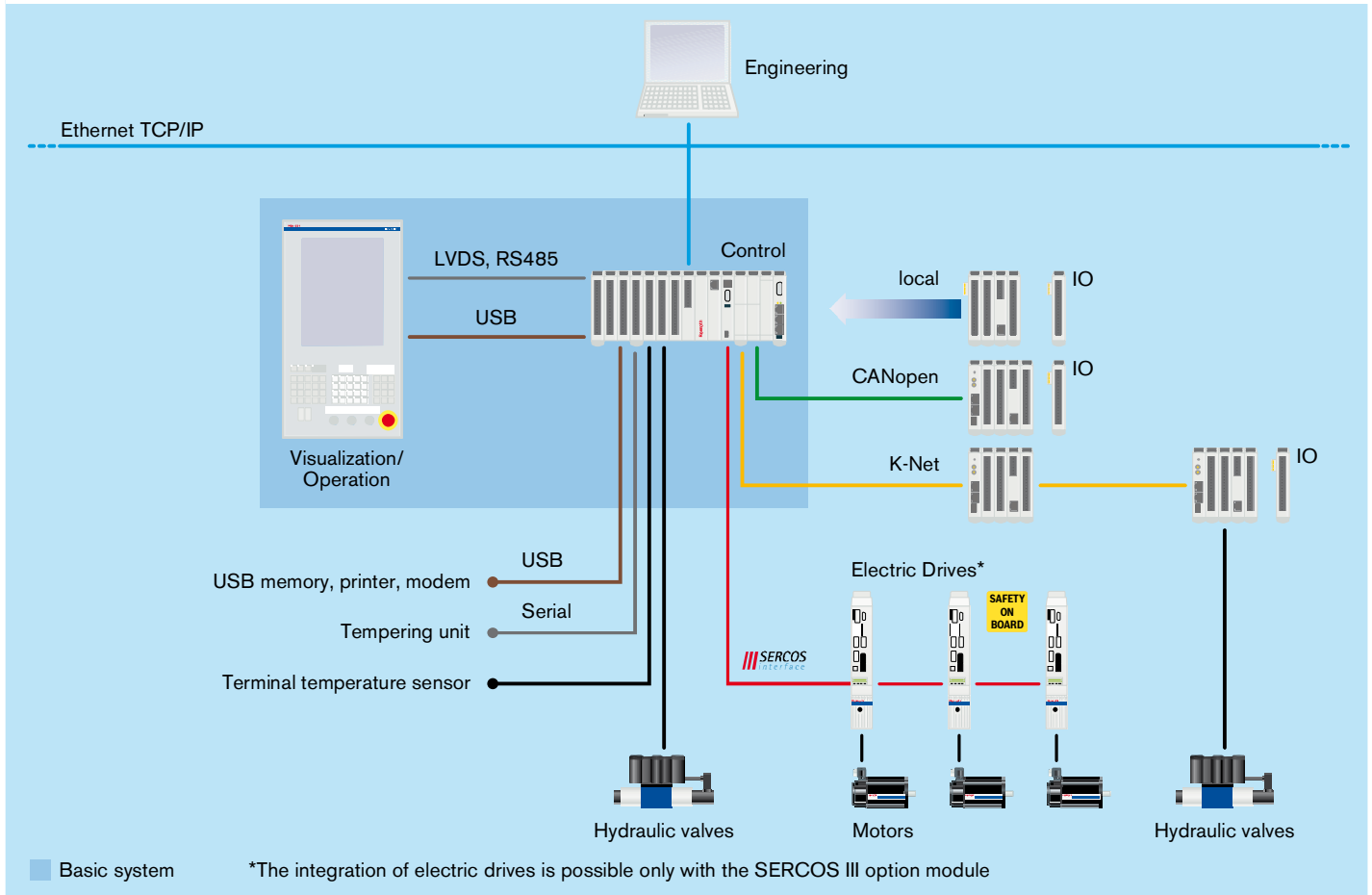

More information in the catalog

IndraMotion for Plastics – comparison of the systems	Chapter 2.4
Control application and engineering tools	Chapter 3.1
Visualization	Chapter 3.2
Operator terminals	Chapter 3.3
Control units	Chapter 3.4
Option module	Chapter 3.5
Expansion modules	Chapter 3.6
Accessories	Chapter 3.7

More information on the Internet at www.boschrexroth.de/mediadirectory

Electric drive technology	Product catalog "Drive System Rexroth IndraDrive"/Document: 71511
	Product catalog "Hydraulic pumps and motors"/Document: RE00112-01
Hydraulic drive technology	Product catalog "Switching valves-Isolator, directional, pressure and flow valves"/Document: RE00112-02
	Product catalog "Servo proportional and high-response valves-Directional, pressure and flow valves"/Document: RE00112-03



IndraMotion for Plastics – comparison of the systems

Controller series	compact	compact plus	universal	universal plus	performance
System version					
Control unit	CP 031	CP 033	CP 250	CP 251	CP 252
CompactFlash slot (CF not part of the basic system)	●	●	●	●	●
Operator terminal connection	LVDS (video), RS485-A (input)	LVDS (video), RS485-A (input)	LVDS (video), RS485-A (input)	LVDS (video), RS485-A (input)	DVI (video), RS485-A (input)
CAN fieldbus connection (CANopen)	–	1	1	1	1
K-Net fieldbus connection	–	–	–	–	2
Ethernet 10/100 Mbit/s	1	1	1	1	1
USB 2.0	1	1	1	1	1
Serial interface (RS232-C/RS485-A)	1	1	–	–	–
Connection for terminal temperature compensation (TE 220/A)	–	1	1	1	1
Slot for optional serial interface	–	–	1	1	1
Slot for optional CAN fieldbus interface	–	–	1	1	1
Slot for optional SERCOS III interface	–	–	1	1	1
Direct plug for expansion modules	–	–	1	1	1
PLC runtime system to IEC 61131-3	●	●	●	●	●
I/O on control unit					
Digital inputs	32	48	32	32	32
Digital outputs	40 (2 A) at 50 % simultaneity	56 (2 A) at 50 % simultaneity	16 (0.5 A) at 100 % simultaneity 24 (2 A) at 50 % simultaneity	16 (0.5 A) at 100 % simultaneity 24 (2 A) at 50 % simultaneity	16 (0.5 A) at 100 % simultaneity 24 (2 A) at 50 % simultaneity
Analog inputs	3 single ended 2 differential	4 single ended 4 differential	4 single ended 4 differential	4 single ended 4 differential	4 single ended 4 differential
Analog outputs	5	6	4	4	4
Thermal inputs	7	8	8	8	8
Operator terminals					
OP 331 (8,4" TFT)	●	●	–	–	–
OP 341 (10,4" TFT)	●	●	–	–	–
OP 340 (10,4" TFT, touchscreen)	–	–	●	●	–
OP 350 (12,1" TFT, touchscreen)	–	–	●	●	–
OP 350-LD (12,1" TFT, touchscreen, RFID, USB)	–	–	–	–	●
OP 362-LD (15" TFT, touchscreen, RFID, USB)	–	–	–	–	●



Controller series	compact	compact plus	universal	universal plus	performance
Visualization					
Presentation	User interface with fixed format	User interface with fixed format	Graphic user interface	Graphic user interface	Graphic user interface
Programming	IEC 61131-3	IEC 61131-3	Java	Java	Java
Programming environment	iecEdit	iecEdit	JBuilder	JBuilder	JBuilder
Version	PLC runtime system on control unit	PLC runtime system on control unit	Java Runtime on control unit	Java Runtime on control unit	Java Runtime on control unit
Supported drive technology					
Electric	–	–	–	●	●
Hydraulic	●	●	●	●	●
Machine types					
Standard machine	●	●	●	●	●
High-speed system	–	–	–	–	●
Multi-component machine	–	–	–	–	●
Distributed, real-time-capable actuator/sensor connection	–	–	–	–	●
Integration of handling systems					
Integrated controller of handling system	–	–	–	–	●
EUROMAP 12/67 interface	○	○	○	○	○
Simulation					
Simulation of the application on PC	–	–	●	●	●
Order data with					
OP 331	IMPL-1070-0000-00	IMPL-1070-0300-00	–	–	–
OP 341	IMPL-1075-0000-00	IMPL-1075-0300-00	–	–	–
OP 340	–	–	IMPL-2075-0000-00	IMPL-2075-0100-00	–
OP 350	–	–	IMPL-2080-0000-00	IMPL-2080-0100-00	–
OP 350-LD	–	–	–	–	IMPL-5080-0000-00
OP 362-LD	–	–	–	–	IMPL-5085-0000-00

- Standard
- Option



Control components – IndraMotion for Plastics

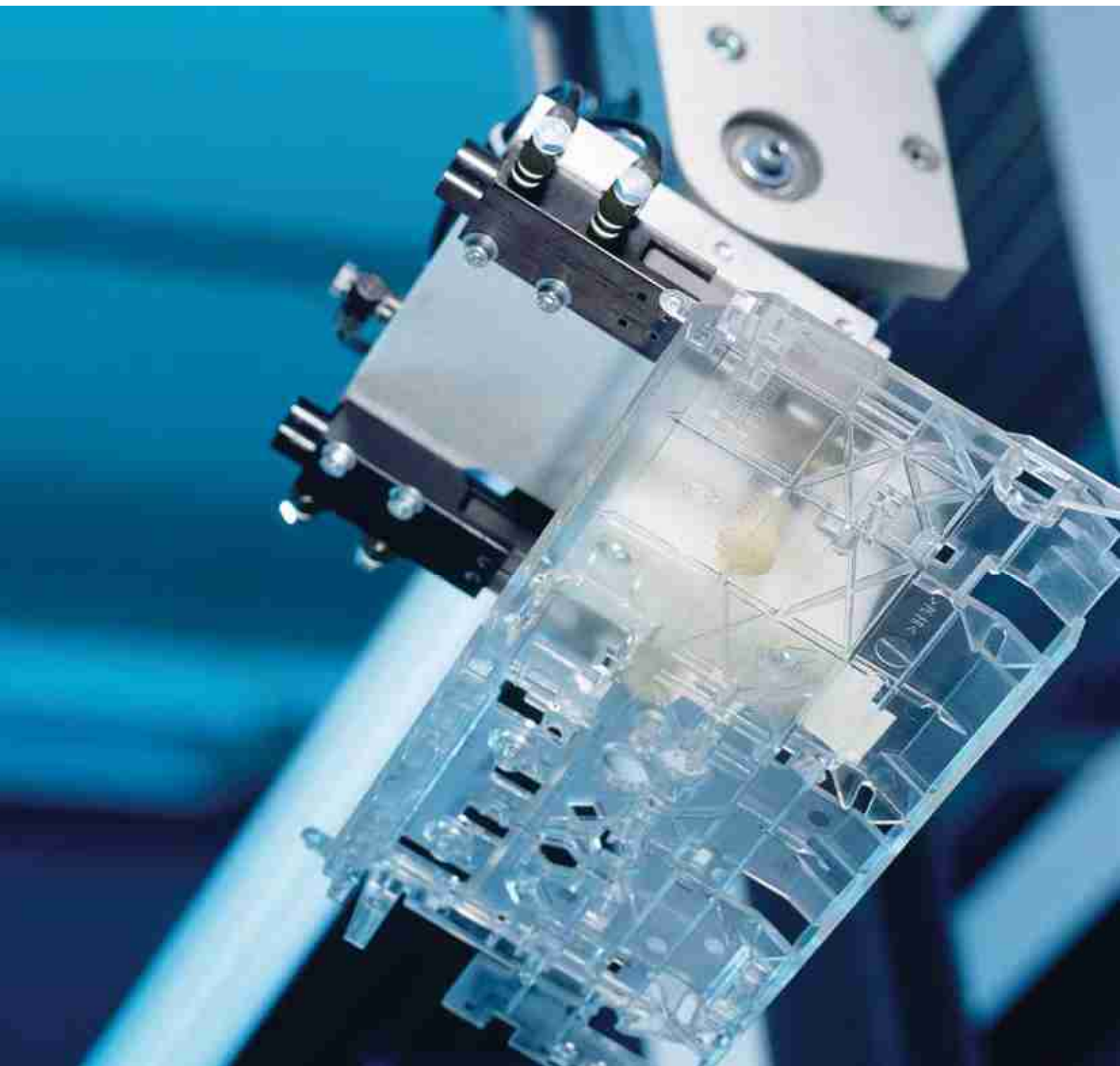



Control application and engineering tools	<u>22</u> 3.1
Visualization	<u>24</u> 3.2
Operator terminals	<u>26</u> 3.3
Control units	<u>32</u> 3.4
Option modules	<u>38</u> 3.5
Expansion modules	<u>42</u> 3.6
Accessories	<u>52</u> 3.7

Control components
21
03

Control application and engineering tools

The system software includes everything required for the quick and easy development of injection molding applications. For example, there is a ready-to-use basic application for fast automation of standard hydraulic injection molding machines. Complex injection molding applications, on the other hand, can be configured using the framework provided by IndraMotion for Plastics. Together with a comprehensive selection of ready-made functional units based on the plug & play principle. And for fast engineering and commissioning there are powerful development and diagnosis tools.

Basic application

Ready-made basic applications for the easy implementation of standard hydraulic injection molding machines are available in all IndraMotion for Plastics versions. They can be used to automate simple machines without any engineering work on the control and visualization program. At the same time the basic application provides the control program platform for more complex machines with electric or hybrid drives.

Framework

The framework, which is structured according to machine functions, permits the quick and easy adaptation of the control application to the different needs of machines and lines. Individual functions can be localized, modified or replaced in minimum time. These functions are implemented in so-called functional units which are registered in the framework when the system is started and then are executed automatically. There is a large choice of special functional units which can be integrated in the framework on the basis of the plug and play principle. The higher-level visualization system detects the active functional units and adjusts dynamically.

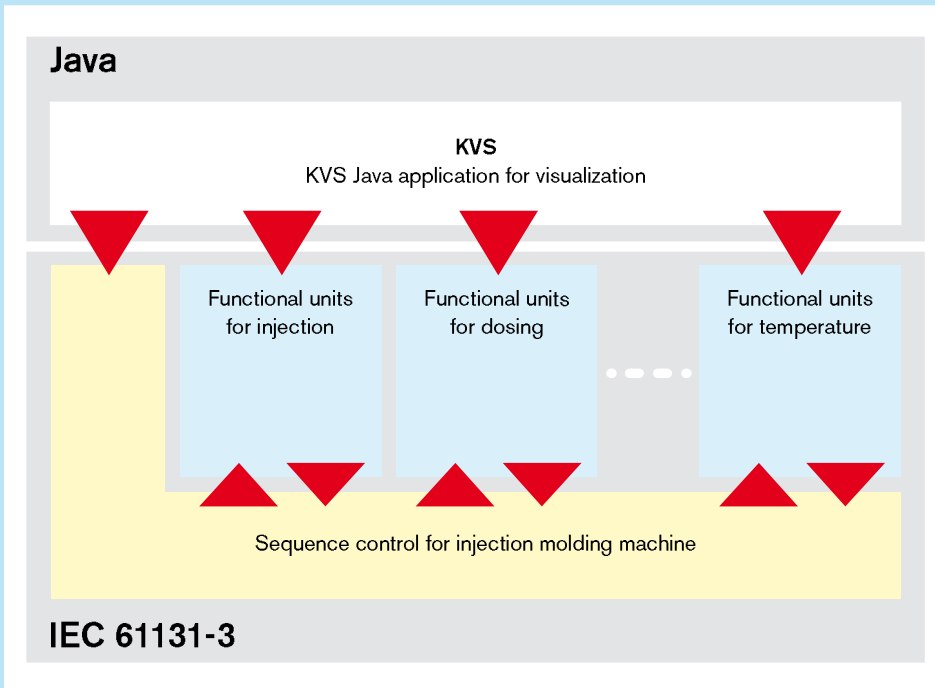

Structure of the framework



manager – the system configurator

With the "manager" you can configure all the hardware and software components of an "IndraMotion for Plastics" control system. Modules are created in the system and I/O points assigned to the system variables in the software. An online function permits hardware and software diagnosis, e.g. the forcing of I/O values or the taking of performance measurements.

iecEdit – the IEC program environment

With "iecEdit" you can program the machine workflow and process control system and manage the source codes and the libraries. "iecEdit" supports the following IEC 61131-3-compliant programming languages: LD, ST, SFC and FBD. Features such as overview windows, syntax coloring, tabular variable declaration and a project-wide search function make programming easier. Functions such as breakpoints, watchpoints and step mode help with the localizing of errors.

translator – the language manager

With the "translator" you can easily manage multiple language-related operator texts for the visualization systems and can edit new contents more quickly. Using the import/export function it is possible to extract texts from the control project and reintegrate them again after translation. The use of Unicode character sets supports international characters and the country-specific presentation of the operator texts.

scope – the process diagnosis tool

"scope" monitors, records and visualizes the control systems' process variables. Unlike a debugger, the program flow does not have to be interrupted for the recording. Tables, diagrams and a 3D view visualize the recorded values.

usoview – the control unit diagnosis tool

With "usoview", status information can be read out for a detailed system diagnosis of the control unit. The system object status (e.g. task, timer, event), the current system configuration and the I/O point status can be determined, and the current system messages acknowledged. For offline diagnosis at a later time, the status report function saves the current system status in a file.

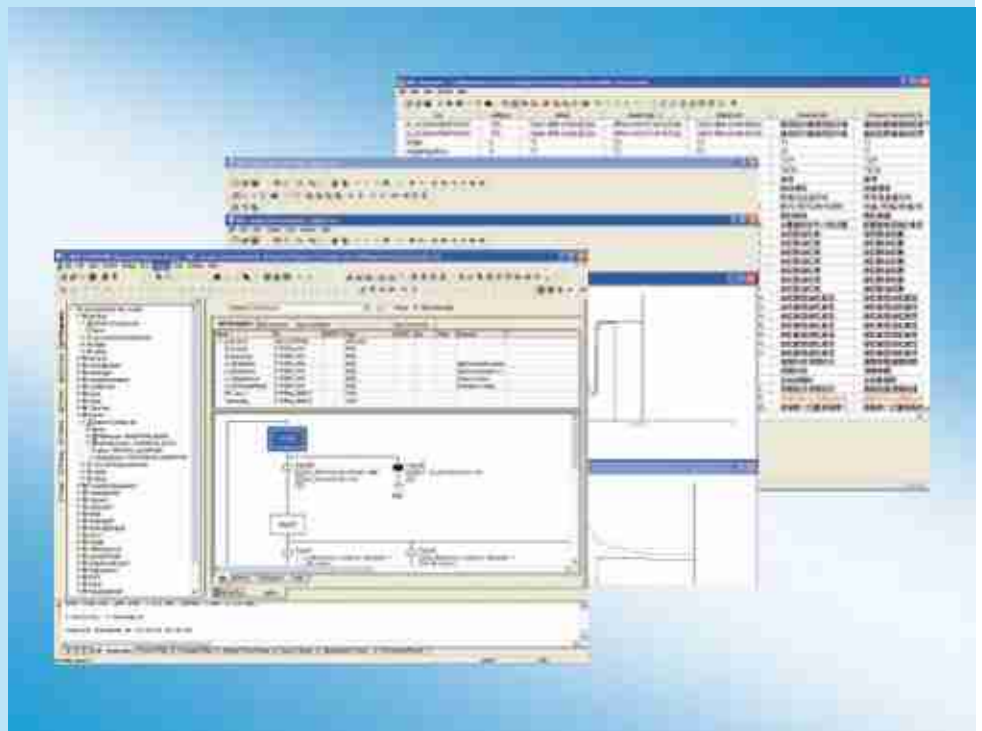

Visualization

All "IndraMotion for Plastics" visualizations are easy to create and user-friendly to operate. Configuration takes place either directly in the controller application or in the JBuilder development environment which basis on the Java technology. Available for this purpose is a selection of special ready-made masks and visualization elements in the form of JavaBeans. Integrated diagnosis tools and basic services such as an I/O monitor, alarm manager and process data monitor facilitate commissioning and servicing.

JavaBeans – ready-made objects

To configure the visualization there are defined masks and objects in the form of JavaBeans, e.g. for process data recording and monitoring, alarm and user management, commissioning and diagnosis. The JavaBeans are provided as a library and can be positioned in the screen mask by drag and drop. The programming of individual masks and process-specific expansions is performed likewise in Java. This reduces the configuration work for visualizations to a minimum.

KVB – instant use

The visualization of the "compact" systems is programmed directly in the controller application on the basis of IEC 61131-3. An easy-to-use library is available for this purpose.

KVS – multiple use

KVS is the process visualization for the "universal" and "performance" systems. Configuration is performed with Java technology and the help of defined JavaBeans. User-specific operator interfaces with a consistent look and feel can be created quickly and economically. Once an interface has been created it will be shown in the correct size and resolution on every visualization in the system. "IndraMotion for Plastics" systems have a system-wide language and units selection function and are able to integrate an own online Help in HTML format. Additional functions such as the automatic sending of e-mails from the controller in the event of machine malfunctions round off the user-friendly operation and service features.





services – controller-integrated support

Depending on the version, the control units provide a variety of service information for the visualization. Several ready-made service interfaces based on the KVS visualization system are available in different levels of expansion depending on the system.

opc – open communication

The OPC server is a standardized interface on Windows-based PCs for exchanging a control unit's process, machine and system data. Third-party OPC client applications such as higher-level PLCs or visualizations can therefore communicate with the control system.

Controller-integrated services of IndraMotion for Plastics	compact	universal	performance
Oscilloscope	-	-	●
Chatroom	-	-	●
Alarm/e-mail	-	-	●
Quality data statistics	-	-	●
Variables monitor	-	●	●
Quality data graphics	-	●	●
Integrated help system	●	●	●
Status report	●	●	●
Quality data protocol	●	●	●
I/O monitor	●	●	●
Tool data manager	●	●	●
Alarm manager	●	●	●

Operator terminals

The operator terminals of the "Indra-Motion for Plastics" automation system were developed specially for the visualization and operation of injection molding machines. Depending on the system version, the HMI terminals come with different performance data and function features and can be adapted exactly to the machine-specific requirements. For example, terminals are available with different display dimensions and formats, touchscreen and membrane keyboard operation, diverse interfaces and user identification.

Two operator terminals with different functionalities are available for every system version. The terminals of the "compact" series are suitable in particular for the operation of hydraulic injection molding machines. The operator terminals of the "universal" and "performance" can also be used for the visualization of fully electric and hybrid machines.

All functions at a glance:

OP 331

- "compact" series
- 8.4" color TFT display
- 58 membrane keys

OP 340

- "universal" series
- 10.4" color TFT display
- 36 membrane keys
- touchscreen

OP 341

- "compact" series
- 10.4" color TFT display
- 63 membrane keys

OP 350

- "universal" series
- 12.1" color TFT display
- 48 membrane keys
- touchscreen

OP 350-LD

- "performance" series
- 12.1" color TFT display
- 56 membrane keys
- touchscreen
- 4 USB ports
- RFID module

OP 362-LD

- "performance" series
- 15" color TFT display
- 56 membrane keys
- touchscreen
- 4 USB ports
- RFID module

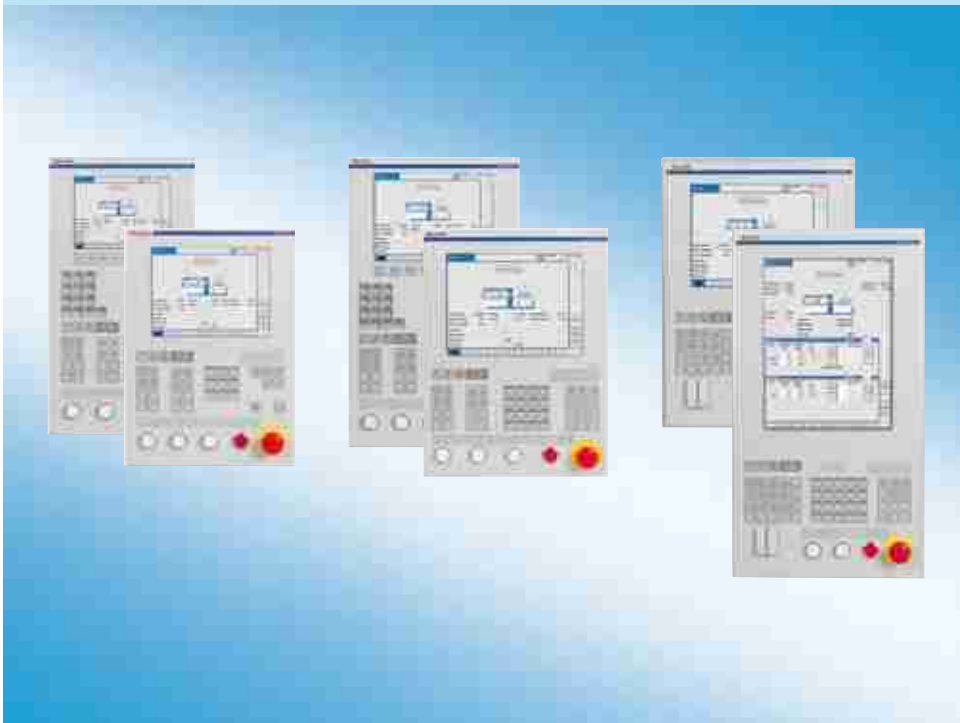



OP 331

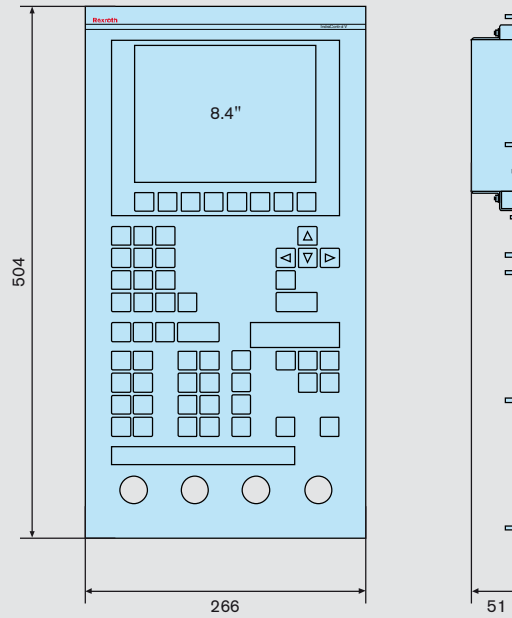

OP 340

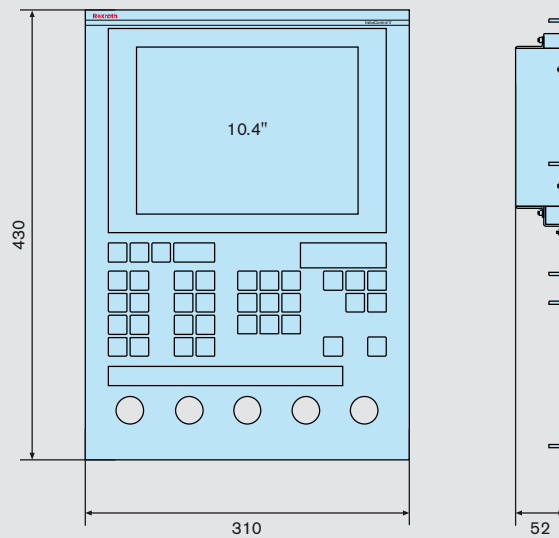

Operator terminals

OP 341

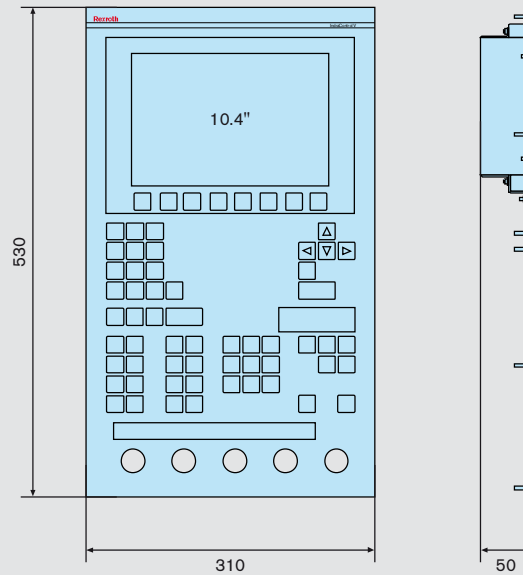

OP 350

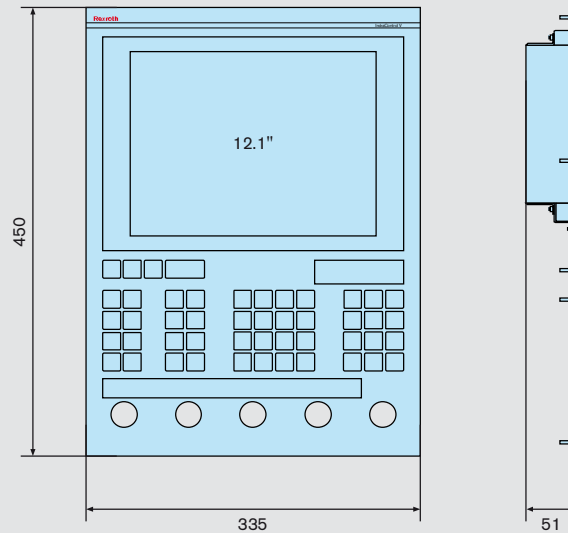





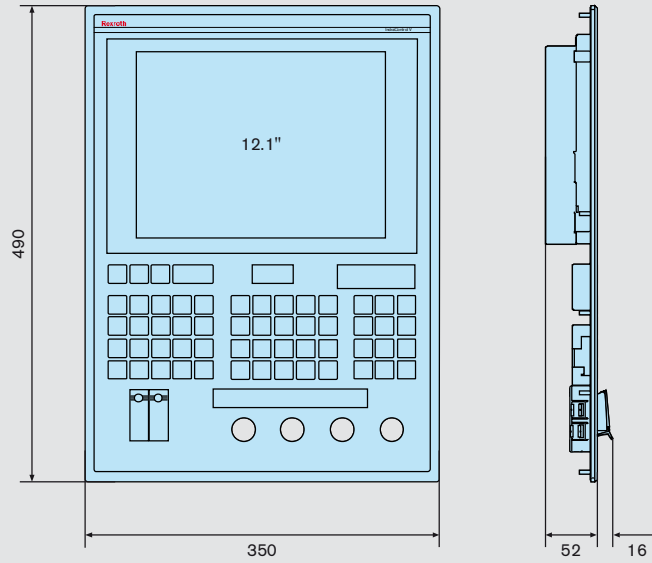

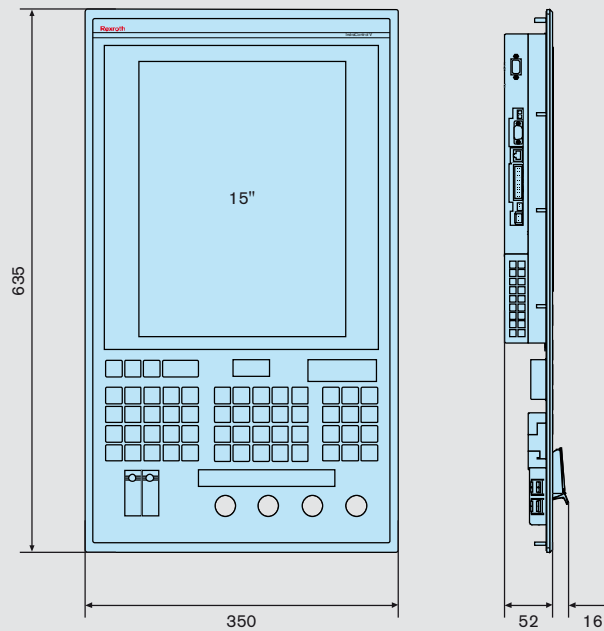

OP 350-LD



OP 362-LD



Operator terminals – technical data

Operator terminals	OP 331	OP 340	OP 341	OP 350	OP 350-LD	OP 362-LD
						
Order data (type code)	IMPL-OP 331/ R-1100	IMPL-OP 340/ R-1100	IMPL-OP 341/ R-1100	IMPL-OP 350/ R-1100	IMPL-OP 350-LD/ R-0140	IMPL-OP 362-LD/ R-0140

General						
Supply voltage	24 VDC (voltage limits according to IEC 61131-1)	24 VDC (voltage limits according to IEC 61131-1)	24 VDC (voltage limits according to IEC 61131-1)	24 VDC (voltage limits according to IEC 61131-1)	24 VDC (voltage limits according to IEC 61131-1)	24 VDC (voltage limits according to IEC 61131-1)
Max. power consumption	30 W	30 W	30 W	30 W	30 W	40 W
Visualization software	KVB	KVS	KVB	KVS	KVS	KVS
Display	8.4" TFT, color	10.4" TFT, color, touchscreen	10.4" TFT, color	12.1" TFT, color, touchscreen	12.1" TFT, color, touchscreen	15" TFT, color, touchscreen
Resolution	800 x 600	800 x 600	800 x 600	800 x 600	800 x 600	768 x 1,024
Interface	LVDS (video) RS485-A (input)	LVDS (video) RS485-A (input)	LVDS (video) RS485-A (input)	LVDS (video) RS485-A (input)	DVI (video) RS485-A (input) 4 x USB (2 at front, 2 at rear)	DVI (video) RS485-A (input) 4 x USB (2 at front, 2 at rear)
Membrane keyboard	58 membrane keys with edge embossing	36 membrane keys with edge embossing	63 membrane keys with edge embossing	48 membrane keys with edge embossing	56 membrane keys with edge embossing	56 membrane keys with edge embossing
Integrated RFID reader	-	-	-	-	According to ISO 15693 or ISO 18000-3 (EU-ROMAP 65-compatible, frequency range: 13.56 MHz)	According to ISO 15693 or ISO 18000-3 (EU-ROMAP 65-compatible, frequency range: 13.56 MHz)
Digital inputs						
Number of inputs	16 (DI0 to DI15, not IEC-61131-compliant)	16 (DI0 to DI15, not IEC-61131-compliant)	16 (DI0 to DI15, not IEC-61131-compliant)	16 (DI0 to DI15, not IEC-61131-compliant)	16 (DI0 to DI15, not IEC-61131-compliant)	16 (DI0 to DI15, not IEC-61131-compliant)
Electrical isolation	No	No	No	No	No	No
Rated voltage	24 VDC	24 VDC	24 VDC	24 VDC	24 VDC	24 VDC
Min. update cycle	60 ms	60 ms	60 ms	60 ms	60 ms	60 ms
Mechanical data						
Height	504	430	530	450	490	635
Width	266	310	310	335	350	350
Depth	51	52	50	51	52	52
Front plate	Aluminium	Aluminium	Sheet steel	Aluminium	Aluminium	Aluminium



Operator terminals	OP 331	OP 340	OP 341	OP 350	OP 350-LD	OP 362-LD
--------------------	--------	--------	--------	--------	-----------	-----------

Mechanical data

Openings for knob-operated switches	4 (blanking cover not included in delivery)	5 (blanking cover not included in delivery)	5 (blanking cover not included in delivery)	5 (blanking cover not included in delivery)	4 (blanking cover included in delivery)	4 (blanking cover included in delivery)
Protection category at front	IP54	IP65	IP65	IP54	IP65	IP65
Weight	3.6 kg	3.1 kg	4.2 kg	3.5 kg	4.3 kg	7.2 kg

Ambient conditions

Operating temperature	+5 to +55 °C	+5 to +55 °C	+5 to +55 °C	+5 to +55 °C	+5 to +55 °C	+5 to +55 °C
Relative humidity	5 to 95 % (no condensation)	5 to 95 % (no condensation)	5 to 95 % (no condensation)	5 to 95 % (no condensation)	5 to 95 % (no condensation)	5 to 95 % (no condensation)
Vibration resistance	3.5 mm amplitude for $5 \leq g \leq 9$ Hz and 1.0 g for $9 \leq f \leq 150$ Hz	According to IEC 61131	According to IEC 61131	3.5 mm amplitude for $5 \leq g \leq 9$ Hz and 1.0 g for $9 \leq f \leq 150$ Hz	According to IEC 61131	According to IEC 61131
Shock resistance	Max. 15 g, 11 ms (half-sine)	According to IEC 61131	According to IEC 61131	Max. 15 g, 11 ms (half-sine)	According to IEC 61131	According to IEC 61131

Control units

IndraMotion for Plastic has the right control unit for every automation task – be it compact controllers for the economical automation of standard machines or modular control systems which can be adapted as required. They are the very heart of the automation system and integrate into one unit an intelligent PLC runtime system, comprehensive technology functions, tailor-made process visualization and hardware interfaces for connecting actuators, sensors and peripherals.

Control units of the "compact" series save a great deal of space and are optimized in their computer power and I/O connectivity for hydraulic standard injection molding machines. The control units of the "universal" series are characterized by modular expandability and high computer power, which enables them to be used on nearly every machine. For high-end machines where the maximum reproduction of injection molding results is paramount, the control units of the "performance" series provide not only maximum modularity and computer power but also an integrated, real-time-capable field bus interface for the integration of distributed I/O modules.

All functions at a glance:

CP 031

- "compact" series
- Ethernet
- USB 2.0
- 32 DI, 40 DO, 5 AI, 5 AO, 7 TM

CP 033

- "compact" series
- Ethernet
- USB 2.0
- CANopen
- 48 DI, 56 DO, 8 AI, 6 AO, 8 TM

CP 250

- "universal" series
- Ethernet
- USB 2.0
- CANopen
- 32 DI, 40 DO, 8 AI, 4 AO, 8 TM
- 3 slots for optional modules
- expansion modules can be mounted directly end-to-end

CP 251

- "universal" series
- Ethernet
- USB 2.0
- CANopen
- 32 DI, 40 DO, 8 AI, 4 AO, 8 TM
- 3 slots for optional modules
- expansion modules can be mounted directly end-to-end

CP 252

- "performance" series
- Ethernet
- USB 2.0
- CANopen
- K-Net
- 32 DI, 40 DO, 8 AI, 4 AO, 8 TM
- 3 slots for optional modules
- expansion modules can be mounted directly end-to-end





CP 031

Connectivity



Performance



CP 033

Connectivity



Performance

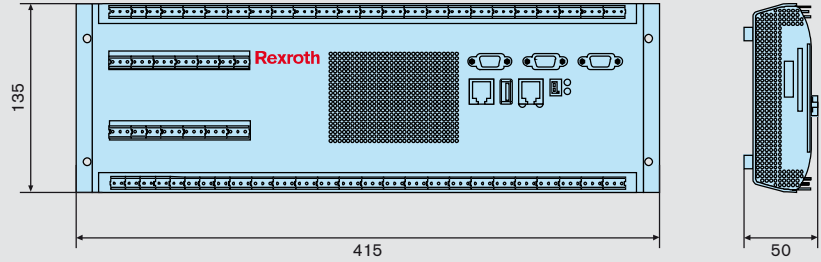

CP 250

Connectivity



Performance



CP 251

Connectivity



Performance



CP 252

Connectivity





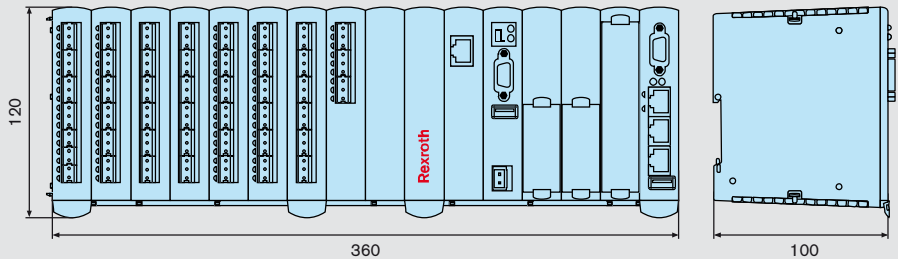

Performance





Control units – technical data

Control unit	CP 031	CP 033	CP 250	CP 251	CP 252
					
Order data (type code)	IMPL-CP 031/Z	IMPL-CP 033/Z	IMPL-CP 250/Z	IMPL-CP 251/Z	IMPL-CP 252/Y
General					
Supply voltage	24 VDC (from the front)	24 VDC (from the front)	24 VDC (from the front)	24 VDC (from the front)	24 VDC (from the front)
Supply voltage range	19.2 to 30 V, according to IEC 61131-2	19.2 to 30 V, according to IEC 61131-2	19.2 to 30 V, according to IEC 61131-2	19.2 to 30 V, according to IEC 61131-2	19.2 to 30 V, according to IEC 61131-2
Max. power consumption	125 W	153 W	99 W	99 W	99 W
Oversvoltage category	II	II	II	II	II
Protection category	III, according to IEC 61131-2	III, according to IEC 61131-2	III, according to IEC 61131-2	III, according to IEC 61131-2	III, according to IEC 61131-2
Electrical isolation	No	No	No	No	No
Fan	Can be replaced from outside	Can be replaced from outside	No fan	No fan	No fan
Computer core					
Processor	PowerPC 400 MHz	PowerPC 400 MHz	Embedded Processor Intel Celeron 400 MHz	Embedded Processor Intel Celeron 700 MHz	Embedded Processor Intel Celeron M 600 MHz
Memory	64 Mb SDRAM	64 Mb SDRAM	256 Mb DDR-SDRAM	256 Mb DDR-SDRAM	256 Mb DDR-SDRAM
SRAM with battery back-up	512 kb	512 kb	512 kb	512 kb	512 kb
Digital inputs					
Number of inputs	32 (DI/V10, DI/V11, DI2 to DI31)	48 (DI/V10, DI/V11, DI2 to DI47)	32	32	32
Electrical isolation	No	No	No	No	No
Input type	Type 1 (according to IEC 61131-2)	Type 1 (according to IEC 61131-2)	Type 1 (according to IEC 61131-2)	Type 1 (according to IEC 61131-2)	Type 1 (according to IEC 61131-2)
Voltage range for "1"	15 V ≤ UH ≤ 30 V	15 V ≤ UH ≤ 30 V	15 V ≤ UH ≤ 30 V	15 V ≤ UH ≤ 30 V	15 V ≤ UH ≤ 30 V
Voltage range for "0"	-3 V ≤ UL ≤ 5 V	-3 V ≤ UL ≤ 5 V	-3 V ≤ UL ≤ 5 V	-3 V ≤ UL ≤ 5 V	-3 V ≤ UL ≤ 5 V
Speed inputs (DI/V10, DI/V11)					
Min. signal input frequency	0.5 Hz	0.5 Hz	–	–	–
Max. signal input frequency	100 Hz	100 Hz	–	–	–
Counter resolution	16 bit	16 bit	–	–	–
Digital outputs 0.5 A					
Number of outputs	–	–	16 (2 groups of 8 outputs with own supply)	16 (2 groups of 8 outputs with own supply)	16 (2 groups of 8 outputs with own supply)
Rated voltage	–	–	24 VDC	24 VDC	24 VDC
Rated current	–	–	0.5 A	0.5 A	0.5 A
Simultaneity	–	–	100 %	100 %	100 %
Electrical isolation	–	–	No	No	No
Digital outputs 2 A					
Number of outputs	40	56	24 (3 groups of 8 outputs with own supply)	24 (3 groups of 8 outputs with own supply)	24 (3 groups of 8 outputs with own supply)
Rated voltage	24 VDC	24 VDC	24 VDC	24 VDC	24 VDC



Control unit	CP 031	CP 033	CP 250	CP 251	CP 252
Digital outputs 2 A					
Rated current	2 A	2 A	2 A	2 A	2 A
Simultaneity	50 % per group	50 % per group	50 % per group	50 % per group	50 % per group
Electrical isolation	–	–	No	No	No
Groups mutually isolated	–	–	Yes	Yes	Yes
Analog inputs (single ended)					
Number of inputs	3, each with Uref	4, each with Uref	4	4	4
Type	Voltage input	Voltage input	Voltage input	Voltage input	Voltage input
Input range	0 to Uref (10 V)	0 to Uref (10 V)	0 to Uref (10 V)	0 to Uref (10 V)	0 to Uref (10 V)
Input type	Single ended	Single ended	Single ended	Single ended	Single ended
Electrical isolation	No	No	No	No	No
Reference voltage output	10 V (±2.5 %, max. 20 mA)	10 V (±2.5 %, max. 20 mA)	10 V (±2.5 %, max. 20 mA)	10 V (±2.5 %, max. 20 mA)	10 V (±2.5 %, max. 20 mA)
Resolution	14 bit	14 bit	14 bit	14 bit	14 bit
Analog inputs (differential or single ended)					
Number of inputs	2 (AI4/AI5 with Iref)	4 (AI4/AI5 with Iref, AI6/AI7)	4 (AI4 to AI7)	4 (AI4 to AI7)	4 (AI4 to AI7)
Type	Voltage input	Voltage input	Voltage input	Voltage input	Voltage input
Input range	0 to 10 V	0 to 10 V	±10 V or 0 V to Uref (10 V)	±10 V or 0 V to Uref (10 V)	±10 V or 0 V to Uref (10 V)
Input type	Differential	Differential	Differential or single ended	Differential or single ended	Differential or single ended
Electrical isolation	No	No	No	No	No
Resolution	14 bit	14 bit	15 bit (±10 V), 14 bit (0 V to Uref)	15 bit (±10 V), 14 bit (0 V to Uref)	15 bit (±10 V), 14 bit (0 V to Uref)
Analog voltage outputs					
Number of outputs	5	6	4	4	4
Type	Single ended	Single ended	Single ended	Single ended	Single ended
Output range	±10 V	±10 V	±10 V	±10 V	±10 V
Electrical isolation	No	No	No	No	No
Resolution	12 bit	12 bit	12 bit	12 bit	12 bit
Analog current outputs					
Number of outputs	3	4	–	–	–
Type	PWM, two-point control- ler with dyn. controlled current hysteresis	PWM, two-point control- ler with dyn. controlled current hysteresis	–	–	–
PWM output voltage	38 V (±5 %)	38 V (±5 %)	–	–	–
Max. switching frequency	20 kHz	20 kHz	–	–	–
Typ. switching frequency	5 kHz (load-dependent frequency targeted using dynamic controlled current hysteresis)	5 kHz (load-dependent frequency targeted using dynamic controlled current hysteresis)	–	–	–
Output current	1 A (±5 %)	1 A (±5 %)	–	–	–
Temperature inputs					
Number of inputs	7	8	8	8	8



Control Units – Technical Data

Control unit	CP 031	CP 033	CP 250	CP 251	CP 252
Temperature inputs					
Electrical isolation	Yes, from the control electronics and from each other (voltage resistance 707 VDC)	Yes, from the control electronics and from each other (voltage resistance 707 VDC)	Yes, from the control electronics and from each other (voltage resistance 707 VDC)	Yes, from the control electronics and from each other (voltage resistance 707 VDC)	Yes, from the control electronics and from each other (voltage resistance 707 VDC)
Thermocouple types	J, K, L	J, K, L	J, K, L	J, K, L	J, K, L
Resolution of the measurement method	14 bit	14 bit	14 bit	14 bit	14 bit
Interfaces					
K-Net interface (on board)	–	–	–	–	Cable connection to remote K-Net stations (50 Mbit/s)
CAN interface (on board)	–	Baud rate can be set via software	Baud rate can be set via software (max. 1 Mbaud)	Baud rate can be set via software (max. 1 Mbaud)	Baud rate can be set via software (max. 1 Mbaud)
Serial interface (on board)	–	RS232-C and RS485-A can be selected via software	–	–	–
Ethernet interface (on board)	10/100 Mbit/s	10/100 Mbit/s	10/100 Mbit/s	10/100 Mbit/s	10/100 Mbit/s
USB (on board)	USB 2.0	USB 2.0	USB 2.0	USB 2.0	USB 2.0
Compact-Flash card	Typ 1	Typ 1	Typ 1	Typ 1	Typ 1
Sensor connection for TE 220/A	–	Yes	Yes	Yes	Yes
Slot for serial interfaces	–	–	Yes	Yes	Yes
Slot for CAN expansion module	–	–	Yes	Yes	Yes
Slot for PCI interfaces	–	–	Yes	Yes	Yes
Connection for operator terminal	LVDS (video) and RS485-A (input)	LVDS (video) and RS485-A (input)	LVDS (video) and RS485-A (input)	LVDS (video) and RS485-A (input)	LVDS (video) and RS485-A (input)
Mechanical data					
Height	135 mm	135 mm	120 mm	120 mm	120 mm
Width	415 mm	415 mm	360 mm	360 mm	360 mm
Depth	50 mm	50 mm	100 mm	100 mm	100 mm
Mounting type	Horizontal mounting on the control cabinet rear panel using mounting holes in the base cover	Horizontal mounting on the control cabinet rear panel using mounting holes in the base cover	DIN rail mounting (TS 35 x 7.5)	DIN rail mounting (TS 35 x 7.5)	DIN rail mounting (TS 35 x 7.5)
Protection category	IP20	IP20	IP20	IP20	IP20
Weight	1,778 g	1,778 g	1,630 g	1,630 g	1,630 g
Ambient conditions					
Operating temperature	+5 to +55 °C	+5 °C to +55 °C	+5 to +55 °C	+5 to +55 °C	+5 to +55 °C
Storage temperature	–40 to +70 °C	–40 to +70 °C	–40 to +70 °C	–40 to +70 °C	–40 to +70 °C
Relative humidity	10 to 95 % (no condensation)	10 to 95 % (no condensation)	10 to 95 % (no condensation)	10 to 95 % (no condensation)	10 to 95 % (no condensation)
Vibration resistance	According to IEC 61131-2	According to IEC 61131-2	According to IEC 61131-2	According to IEC 61131-2	According to IEC 61131-2
Shock resistance	According to IEC 61131-2	According to IEC 61131-2	According to IEC 61131-2	According to IEC 61131-2	According to IEC 61131-2



Option modules

Openness and interface flexibility allows optimum connectivity options to the process and peripherals, and are key characteristics of IndraMotion for Plastics. Important interfaces are already integrated in the control units. If other interfaces are needed, they are easily added by means of option modules. This can be the case for example, if you want to connect distributed actuators and sensors or actuate electric drives.

Option modules are available for the "universal" and "performance" series. The modules are plugged directly into the slots provided on the control unit, so there is no installation work required. Retrofits are simple and take up no additional space in the control cabinet.

All functions at a glance:

SX 210/A

- serial interface RS232-C
- slot 1

SX 230/A

- serial interface RS485-A/RS422-A
- slot 1

FX 200/A

- CAN interface for connecting distributed actuators and sensors
- slot 2

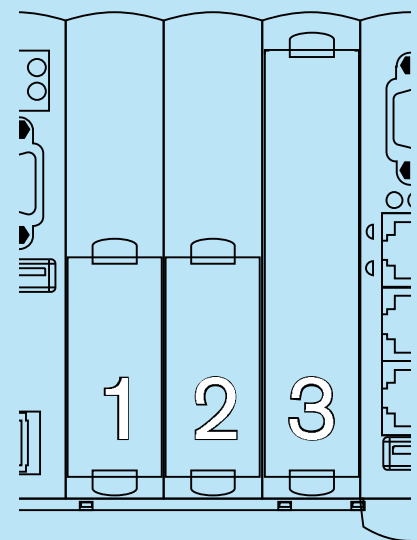

FX 271/A

- SERCOS III master for connecting the Rexroth IndraDrive electric drive system and hydraulic drives
- slot 3





Serial interfaces – technical data

Option module	SX 210/A	SX 230/A
		
Order data (type code)	IMPL-SX 210/A	IMPL-SX 230/A
Serial interface		
Type of interface	RS232-C, 9-pole pin plug	RS485-A/RS422-A, 9-pole pin plug
Transmission medium	Cable (shielded)	Cable (shielded)
Electrical isolation	No	No
Baud rates of RS232-C	Can be set via software (1,200 to 115,000 baud)	–
Baud rates of RS485-A/RS422-A	–	Can be set via software (1,200 to 115,000 baud)
Selection between RS485-A and RS422-A	–	Can be set via software
Mechanical system		
Design	No housing, only front panel mounted on pcb	No housing, only front panel mounted on pcb
Protection category	IP20 for CP 25x/x with inserted module	IP20 for CP 25x/x with inserted module
Weight	31 g	31 g
Ambient conditions		
Operating temperature	+5 to +55 °C	+5 to +55 °C
Storage temperature	–40 to +70 °C	–40 to +70 °C
Relative humidity	10 to 95 % (no condensation)	10 to 95 % (no condensation)
Vibration resistance	According to IEC 61131-2	According to IEC 61131-2
Shock resistance	According to IEC 61131-2	According to IEC 61131-2



CAN interface – technical data

Option module	FX 200/A
	
Order data (type code)	IMPL-FX 200/A
CAN interface	
Baud rate	125 kbit/s, 250 kbit/s, 500 kbit/s, 800 kbit/s, 1 Mbit/s
Terminal resistance	Yes, can be jumpered in the plug
Electrical isolation	No
Connection	D-SUB, 9-pole pin plug
Signaling	2 LEDs: yellow = transmit, green = receive
Mechanical system	
Design	No housing, only front panel mounted on pcb
Protection category	IP20 for CP 25x/x with inserted module
Weight	27 g
Ambient conditions	
Operating temperature	+5 to +55 °C
Storage temperature	-40 to +70 °C
Relative humidity	10 to 95 % (no condensation)
Vibration resistance	According to IEC 61131-2
Shock resistance	According to IEC 61131-2



SERCOS III interface – technical data

Option module	FX 271/A
	
Order data (type code)	IMPL-FX 271/A
SERCOS III interface	
Baud rate	100 Mbit/s
Number	1 (2 Ports)
Connection	Modular plug 8-pole (RJ45 plug)
Electrical isolation	Yes (50 V voltage resistance)
Ethernet interface	
Baud rate	100 Mbit/s
Number	2
Connection	Modular plug 8-pole (RJ45 plug)
Electrical isolation	Yes (50 V voltage resistance)
Mechanical system	
Design	No housing, only front panel mounted on pcb
Protection category	IP20 for CP 25x/x with inserted module
Weight	83 g
Ambient conditions	
Operating temperature	+5 to +55 °C
Storage temperature	-40 to +70 °C
Relative humidity	10 to 95 % (no condensation)
Vibration resistance	According to IEC 61131-2
Shock resistance	According to IEC 61131-2

Expansion modules

The basic versions of the "IndraMotion for Plastics" control units already include numerous on-board inputs and outputs. In applications where even more I/Os are needed for the connection of actuators and sensors or where distributed connections are specified, powerful expansion modules can be added easily and quickly to the control units. This is achieved by mounting end-to-end directly on the control unit or by integrating I/O stations via the fieldbus

With expansion module groups you can adapt the "IndraMotion for Plastics" systems to every automation task – be it the integration of additional probes and relays, the distributed connection of hydraulic valves, or the recording of position data with an incremental position encoder.

There are two ways to integrate the expansion modules in the system:

- direct end-to-end mounting of the modules on the control unit in the control cabinet (only for the CP 25x)
- distributed integration of an I/O station via the fieldbus. Connection to the bus system is then performed with a fieldbus coupler.

All functions at a glance:

Fieldbus coupler – for connecting a distributed I/O station

- CANopen
- K-Net

Digital inputs and outputs – for the recording and control of

- probes
- proximity switches and limit switches
- relays

Analog inputs and outputs – for the recording and control of

- temperature sensors
- hydraulic valves

Function modules – for special tasks

- integration of incremental position encoders
- integration of encoders with SSI interface
- temperature recording with thermocouples

Communication modules – for providing additional interfaces

- SERCOS 2
- RS232/422/485





Fieldbus couplers

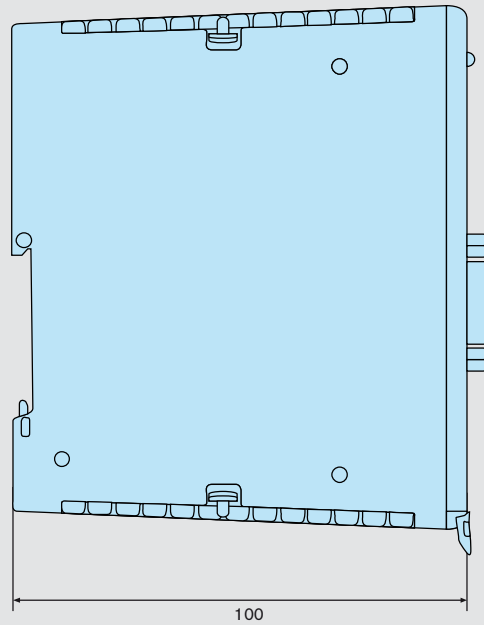
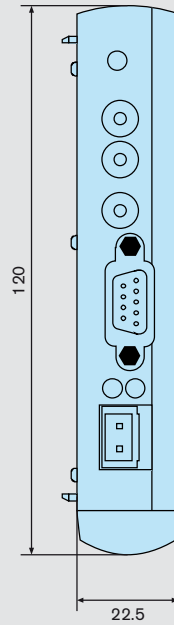

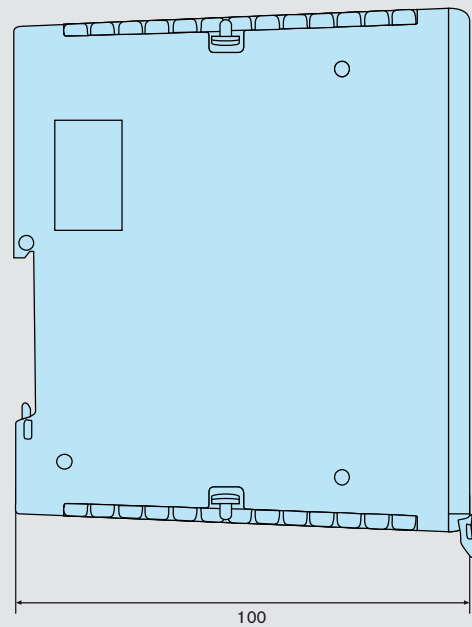
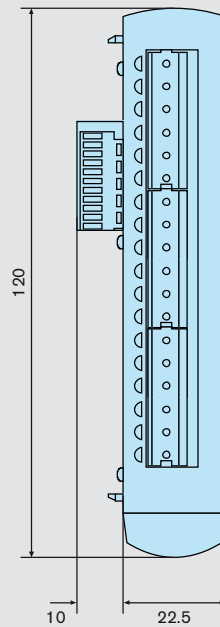

Expansion modules







Fieldbus couplers – technical data

Expansion modules	BL 210/B	BL 250/B
		
Order data (type code)	IMPL-BL 210/B	IMPL-BL 250/B
General		
External supply voltage	24 VDC from the front (19.2 to 30 V, according to IEC 61131-2)	24 VDC from the front (19.2 to 30 V, according to IEC 61131-2)
Supply terminals	Open terminals, modular dimension 5.08 mm	Open terminals, modular dimension 5.08 mm
Setting of bus address	16-digit address switch at the front	16-digit address switch at the front
CAN interface		
CAN interface	9-pole D-sub plug	–
Band rate	Variable by rotary switch (1 Mbit/s, 800 kbit/s, 500 kbit/s, 250 kbit/s, 125 kbit/s)	–
Electrical isolation	No	–
Number	1	–
Bus termination	Can be connected via plug jumper	–
K-Net interface		
K-Net interface	–	RJ45 for cable connection to remote K-Net stations
Baud rate	–	50 Mbit/s
Max. cable length	–	50 m
Electrical isolation	–	No
Number	–	2
Mechanical data		
Height	120 mm	120 mm
Width	22.5 mm	22.5 mm
Depth	100 mm	100 mm
Weight	121 g	142 g
Ambient conditions		
Operating temperature	+5 to +55 °C	+5 to +55 °C
Storage temperature	–40 to +70 °C	–40 to +70 °C
Relative humidity	10 to 95 % (no condensation)	10 to 95 % (no condensation)
Vibration resistance	According to IEC 61131-2	According to IEC 61131-2
Shock resistance	According to IEC 61131-2	According to IEC 61131-2





Digital inputs/outputs – technical data

Expansion module	DI 260/A	DO 272/A	DM 272/A
			
Order data (type code)	IMPL-DI 260/A	IMPL-DO 272/A	IMPL-DM 272/A

General			
External voltage supply	24 VDC from the front (19.2 to 30 V, according to IEC 61131-2)	24 VDC from the front (19.2 to 30 V, according to IEC 61131-2)	24 VDC from the front (19.2 to 30 V, according to IEC 61131-2)
Supply terminals	Open terminals, modular dimension 5.08 mm	Open terminals, modular dimension 5.08 mm	Open terminals, modular dimension 5.08 mm
Digital inputs			
Number of inputs	16	–	8
Input type	Type 1 (according to IEC 61131-2)	–	Type 1 (according to IEC 61131-2)
Voltage range for "1"	15 V ≤ UH ≤ 30 V	–	15 V ≤ UH ≤ 30 V
Voltage range for "0"	–3 V ≤ UL ≤ 5 V	–	–3 V ≤ UL ≤ 5 V
Cycle time	1 ms	–	1 ms
Electrical isolation	Yes	–	Yes
Interrupt inputs			
Number of inputs	2 (DI0, DI1) of the digital inputs	–	2 (DI0, DI1) of the digital inputs
Input type	Type 1 (according to IEC 61131-2)	–	Type 1 (according to IEC 61131-2)
Voltage range for "1"	15 V ≤ UH ≤ 30 V	–	15 V ≤ UH ≤ 30 V
Voltage range for "0"	–3 V ≤ UL ≤ 5 V	–	–3 V ≤ UL ≤ 5 V
Electrical isolation	Yes	–	Yes
Digital outputs			
Number of outputs	–	14	8
Rated voltage	–	24 VDC	24 VDC
Processing time	–	1 ms	1 ms
Rated current	–	2 A at 50 % simultaneity	2 A at 50 % simultaneity
Protective device	–	Short-circuit protection	Short-circuit protection
Electrical isolation	–	Yes	Yes
Mechanical data			
Height	120 mm	120 mm	120 mm
Width	22.5 mm	22.5 mm	22.5 mm
Width incl. K-Bus plug	32.5 mm	32.5 mm	32.5 mm
Depth	100 mm	100 mm	100 mm
Weight	130 g	135 g	135 g
Ambient conditions			
Operating temperature	+5 to +55 °C	+5 to +55 °C	+5 to +55 °C
Storage temperature	–40 to +70 °C	–40 to +70 °C	–40 to +70 °C
Relative humidity	10 to 95 % (no condensation)	10 to 95 % (no condensation)	10 to 95 % (no condensation)
Vibration resistance	According to IEC 61131-2	According to IEC 61131-2	According to IEC 61131-2
Shock resistance	According to IEC 61131-2	According to IEC 61131-2	According to IEC 61131-2





Analog inputs/outputs – technical data

Expansion module	AI 240/A	AO 240/A	AM 282/A
			
Order data (type code)	IMPL-AI 240/A	IMPL-AO 240/A	IMPL-AM 282/A

General			
Supply terminals	Open terminals, modular dimension 5.08 mm	Open terminals, modular dimension 5.08 mm	Open terminals, modular dimension 5.08 mm
Analog inputs			
Number of inputs	4	–	4
Type	Voltage input	–	Voltage input
Resolution	14 bit	–	16 bit
Signal range	±10 V or 0 to Uref (10 V)	–	±10 V or 0 to Uref (10 V)
Input type	Differential or single ended	–	Differential or single ended
Electrical isolation	No	–	No
Reference voltage output	10 V (±2.5 %, max. 20 mA)	–	10 V (±2.5 %, max. 20 mA)
Analog outputs			
Number of outputs	–	4	4
Type	–	Voltage output	Voltage output
Resolution	–	12 bit	14 bit
Signal range	–	±10 V	±10 V
Electrical isolation	–	No	No
Resistive, capacitive load	–	≥ 1kΩ, ≤ 10 nF	≥ 1kΩ, ≤ 10 nF
Mechanical data			
Height	120 mm	120 mm	120 mm
Width	22.5 mm	22.5 mm	22.5 mm
Width incl. K-Bus plug	32.5 mm	32.5 mm	32.5 mm
Depth	100 mm	100 mm	100 mm
Weight	132 g	132 g	135 g
Ambient conditions			
Operating temperature	+5 to +55 °C	+5 to +55 °C	+5 to +55 °C
Storage temperature	–40 to +70 °C	–40 to +70 °C	–40 to +70 °C
Relative humidity	10 to 95 % (no condensation)	10 to 95 % (no condensation)	10 to 95 % (no condensation)
Vibration resistance	According to IEC 61131-2	According to IEC 61131-2	According to IEC 61131-2
Shock resistance	According to IEC 61131-2	According to IEC 61131-2	According to IEC 61131-2



Temperature modules – technical data

Expansion module	TM 220/A	TM 240/A
		
Order data (type code)	IMPL-TM 220/A	IMPL-TM 240/A
General		
Supply terminals	Open terminals, modular dimension 5.08 mm	Open terminals, modular dimension 5.08 mm
Temperature inputs		
Number of inputs	3	6
Electrical isolation	Yes, from the control electronics and from each other	Yes, from the control electronics and from each other
Electrical isolation	14 bit	14 bit
Thermocouple types	J, K, L	J, K, L
Mechanical data		
Height	120 mm	120 mm
Width	22.5 mm	22.5 mm
Width incl. K-Bus plug	32.5 mm	32.5 mm
Depth	100 mm	100 mm
Weight	133 g	142 g
Ambient conditions		
Operating temperature	+5 to +55 °C	+5 to +55 °C
Storage temperature	-40 to +70 °C	-40 to +70 °C
Relative humidity	10 to 95 % (no condensation)	10 to 95 % (no condensation)
Vibration resistance	According to IEC 61131-2	According to IEC 61131-2
Shock resistance	According to IEC 61131-2	According to IEC 61131-2





SERCOS 2 interface – technical data

Expansion module	FM 280/A
	
Order data (type code)	IMPL-FM 280/A
SERCOS 2 interface	
Transmission rates	2 Mbit/s and 4 Mbit/s
Max. cable length (light guide)	Light guide module with threaded connection
Connection	Light guide module with threaded connection
Mechanical data	
Height	120 mm
Width	22.5 mm
Width incl. K-Bus plug	32.5 mm
Depth	100 mm
Weight	121 g
Ambient conditions	
Operating temperature	+5 to +55 °C
Storage temperature	-40 to +70 °C
Relative humidity	10 to 95 % (no condensation)
Vibration resistance	According to IEC 61131-2
Shock resistance	According to IEC 61131-2



Serial interfaces – technical data

Expansion module	SM 210/A	SM 220/A	SM 230/A
			
Order data (type code)	IMPL-SM 210/A	IMPL-SM 220/A	IMPL-SM 230/A

General			
Type of interface	RS232-C, 9-pole D-sub plug	Current loop, 9-pole D-sub plug	RS485-A/RS422-A, 9-pole D-sub plug
Transmission medium	Cable (shielded)	Cable (shielded), 120 Ω	Cable (shielded), 120 Ω
Electrical isolation	No	No	No
Baud rates	Can be set via software (1,200 to 115,000 Baud)	Can be set via software (1,000 to 9,600 Baud)	Can be set via software (1,200 to 115,000 Baud)
Mechanical data			
Height	120 mm	120 mm	120 mm
Width	22.5 mm	22.5 mm	22.5 mm
Width incl. K-Bus plug	32.5 mm	32.5 mm	32.5 mm
Depth	100 mm	100 mm	100 mm
Weight	132 g	132 g	132 g
Ambient conditions			
Operating temperature	+5 to +55 °C	+5 to +55 °C	+5 to +55 °C
Storage temperature	-40 to +70 °C	-40 to +70 °C	-40 to +70 °C
Relative humidity	10 to 95 % (no condensation)	10 to 95 % (no condensation)	10 to 95 % (no condensation)
Vibration resistance	According to IEC 61131-2	According to IEC 61131-2	According to IEC 61131-2
Shock resistance	According to IEC 61131-2	According to IEC 61131-2	According to IEC 61131-2



Incremental encoder interface – technical data

Expansion module	MM 240/A
	

Order data (type code)	IMPL-MM 240/A
-------------------------------	----------------------

General

External supply voltage	24 VDC from the front (19.2 to 30 V, according to IEC 61131-2)
Supply terminals	Open terminals, modular dimension 5.08 mm

Incremental encoder interface

Number	2 ports
Connection	24 V single ended or 5 V differential (A-/B- and zero track), 9-pole D-sub plug
Max. input frequency	250 kHz
Encoder supply	24 V and 5 V
Max. load	100 mA per encoder

Latch inputs

Number	2 inputs
Response time of latch input	20 µs
Circuit	Sink or source input
Electrical isolation	No

Functions

Speed measurement	24 bit counter width, peak time measurement with internal 50 MHz clock pulse
Travel measurement	32 bit counter width, direction detection, 1-, 2- and 4-fold evaluation
Pulse counter on track A	32 bit counter width, with/without direction detection via track B
Rotary encoder monitoring	Using index signal
Latch function of 16 bit counter	Resolution of counter 1µs, trigger via input or index signal
Monitoring	Broken sensor monitoring of tracks A, B and zero (in 5 V diff. mode)
Simulation mode	Application test when encoder is not connected

Monitors

Broken sensor	Broken sensor monitoring of tracks A, B and zero (in 5 V diff. mode)
Index signal	Monitoring the index signal on rotary encoders
Counter overflow	Monitoring the overflow on the 32 bit counter
Limit frequency	Monitoring the max. permissible input frequency (250 kHz)

Mechanical data

Height	120 mm
Width	22.5 mm
Width incl. K-Bus plug	32.5 mm
Depth	100 mm
Weight	135 g

Ambient conditions

Operating temperature	+5 to +55 °C
Storage temperature	-40 to +70 °C
Relative humidity	10 to 95 % (no condensation)
Vibration resistance	According to IEC 61131-2
Shock resistance	According to IEC 61131-2



SSI encoder interface – technical data

Expansion module	SM 250/A
	

Order data (type code)	IMPL-SM 250/A
-------------------------------	---------------

General	
----------------	--

External supply voltage	24 VDC from the front (19.2 to 30 V, according to IEC 61131-2)
Supply terminals	Open terminals, modular dimension 5.08 mm

SSI encoder interface	
------------------------------	--

Number	4 RJ45 ports
Baud rate	125 kbit/s, 250 kbit/s, 500 kbit/s, 1 Mbit/s
Encoder supply	24 V
Max. load	250 mA per encoder
Data bits	Number and encoding can be set via software

Monitors	
-----------------	--

Broken sensor	Monitoring of the differential input
Index signal	–
Counter overflow	–
Limit frequency	–

Mechanical data	
------------------------	--

Height	120 mm
Width	22.5 mm
Width incl. K-Bus plug	32.5 mm
Depth	100 mm
Weight	140 g

Ambient conditions	
---------------------------	--

Operating temperature	+5 to +55 °C
Storage temperature	–40 to 70 °C
Relative humidity	10 to 95 % (no condensation)
Vibration resistance	According to IEC 61131-2
Shock resistance	According to IEC 61131-2

Accessories

Connection systems

Pre-assembled cables with a selection of lengths and plugs are available for connecting distributed modules and operator terminals.

Plug sets for module wiring

Using snap-on connectors you can quickly make connections to sensors/actuators in the field and remove them again without any complex labeling of individual cores. Matching plug sets are available for every module.

Memory card for control units

All operating and application data are saved on a CompactFlash card. This means that all parameters of the control unit and all parameters or the commissioning of series machines can be duplicated quickly and easily.

Terminal temperature sensor

Designed for external terminal temperature compensation in conjunction with the temperature inputs of the control unit or the temperature module. The sensor must be used when the thermoelement leads are connected in series. It can be attached to the terminal either with a cable tie or adhesive.

RFID card for user authentication

The "performance" system is equipped for contactless user identification using RFID cards (RFID = Radio Frequency Identification). Access authorization for operating the machine could not be more easily arranged and there is no more time-consuming logging in with a user name and password.





Accessories – order data

Order data for connection systems	
Description	Type code
K-Net cables	
Cable for connecting the bus coupling module BL 250/B to the K-Net fieldbus, length: 1.5 m	IMPL-XW 000-015
Cable for connecting the bus coupling module BL 250/B to the K-Net fieldbus, length: 6 m	IMPL-XW 000-060
Cable for connecting the bus coupling module BL 250/B to the K-Net fieldbus, length: 10 m	IMPL-XW 000-100
CAN cables	
Cable for connecting the bus coupling module BL 210/B to a control unit, length: 0.8 m	IMPL-XW 010-008
Cable for connecting the bus coupling module BL 210/B to a control unit, length: 5 m	IMPL-XW 010-050
Cable for connecting the bus coupling module BL 210/B to a control unit, length: 7 m	IMPL-XW 010-070
Connecting cable for operator terminal/control unit	
Cable for connecting the OP 3xx operator terminal to the CP 25x control units (included in delivery of the basic system)	IMPL-XW 041-050
USB connecting cable for OP 3xx-LD operator terminals	
Cable for connecting the USB module integrated in the OP 3xx-LD operator terminal to the XE012/A FAR-USB module, length: 5 m (included in delivery of the "performance" basic system)	IMPL-XW 040-050
Cable for connecting the USB interface of the CP 25x control unit to the XE012/A FAR-USB module (included in delivery of the "performance" basic system)	IMPL-USB-A-USB-B
FAR-USB module for connecting the USB module integrated in the OP 3xx-LD operator terminal to the USB interface of the CP 25x control unit (included in delivery of the "performance" basic system)	IMPL-XE 012/A
Connecting cable for SSI absolute encoder	
RJ45 cable for connecting the SSI interface expansion module SM 250/A to the SSI absolute encoder	IMPL-XW 405-100
Order data for plug sets	
Description	Type code
Plug set for the fieldbus coupling modules BL 210/B; BL 250/B	IMPL-XT 005/A
Plug set for the temperature module TM 220/A	IMPL-XT 015/A
Plug set for the analog output module AO 240/A	IMPL-XT 020/A
Plug set for the temperature module TM 240/A	IMPL-XT 025/A
Plug set for the analog module AI 240/A; AM 282/A; digital modules DI 240/A; DI 260/A; DM 260/A; DM 272/A; DO 242/A; DO 272/A;	IMPL-XT 030/A
Plug set for the "compact" system IMPL-i1070-0000-00 and i1075-0000-00 with CP 031/Z	IMPL-XT 390/A
Plug set for the "compact plus" system IMPL-i1070-0300-00 and i1075-0300-00 with CP 033/Z	IMPL-XT 395/A
Plug set for the "universal" and "performance" systems IMPL-i2575-0000-00, IMPL-i2575-0100-00, IMPL-i2580-0100-00 IMPL-i5080-0000-00, IMPL-i5085-0000-00	IMPL-XT 375/A
Order data for Compact-Flash card	
Description	Type code
CompactFlash memory card, 256 MB (not included in delivery of the basic system)	IMPL-CompactFlash
Order data for terminal temperatur sensor	
Description	Type code
Terminal temperature sensor for the control units CP xxx and the temperature measuring modules TM 220/A and TM 240/A	IMPL-TE 220/A
Order data for RFID card	
Description	Type code
RFID card for user authentication on OP 3xx-LD operator terminals	IMPL-XC 140/A



Glossary

CAN CAN (Controller Area Network) – asynchronous, serial bus system. Is used together with CANopen in automation systems for the networking of control components.

CANopen CANopen is a 7 layer communication protocol based on CAN for the networking of control components. It is standardized compliant with the European standard IEC 50325-4.

CF CompactFlash – an interface standard for digital storage media.

Ethernet Cable-bound transmission method for building local data networks. Ethernet defines the access to a transmission medium and the data transmission method. Ethernet is standardized in IEEE 802.3.

FBD Function Block Diagram – a graphic programming language compliant with IEC 61131-3. It comprises mainly Boolean algebra logic symbols and is suitable in particular for the programming and diagnosis of logic operations.

Fieldbus A cable-bound communication system that interlinks control units, sensors and actuators. Standardized compliant with IEC 61158.

High-speed system An injection molding machine with very short process cycles. This is achieved for example through minimal control cycles.

HMI Human Machine Interface – a system for monitoring and operating machines and lines.

IL Instruction List – a programming language compliant with IEC 61131-3. Uses assembler-like syntax.

K-Bus A local bus which the expansion modules use to communicate with the controller or fieldbus coupling module.

K-Net A fieldbus based on Ethernet. The data are transmitted in deterministic mode in real-time in order to enable short response times to the process. K-Net is particularly well suited for control systems with distributed actuators and sensors.

LD Ladder Diagram – a graphic programming language compliant with IEC 61131-3. Its presentation is similar to that of electric circuits. It is suitable in particular for the programming and diagnosis of logic operations.

Master A central bus station which controls access to the bus.

Memory card A memory card is a compact, rewritable digital storage medium on which random data can be stored in a file system.

Multi-component machine An injection molding machine with more than one injection unit. It is thus possible for example to manufacture multi-colored molded parts.

OPC An interface standard which defines various ways of accessing information in the process such as variables, alarms and archive data. The OPC interface specifies the exchange of data between OPC servers and OPC clients. The OPC server provides the information and the OPC client fetches the information and processes it further.

PLC Programmable Logic Controller – a programmable module which is used for controlling a machine or line in open-loop or closed-loop mode. Such a module is generally an electronic module. The requirements to be met by the control hardware, runtime system and programming are standardized in IEC 61131.



RFID

Radio Frequency Identification – enables the cableless reading of information with the help of electromagnetic waves. An RFID system is comprised of a transponder, which contains the information, and a reader.

SERCOS 2

Serial Realtime Communications Standard Interface – an open and serial real-time communication standard for high-precision Motion Control applications, designed by leading manufacturers for NC drives.

SERCOS III

Third generation of SERCOS – a further development of the SERCOS 2 standard, compliant with IEC/EN 61491 and based on standard Ethernet. Familiar SERCOS mechanisms such as Motion Control profiles, telegram structure and hardware synchronization were adopted in this new generation for real-time communication.

SFC

Sequential Function Chart – a graphic programming language compliant with IEC 61131-3. It is particularly well suited for programming sequential workflows.

Slave

A network station which can participate in the data exchange only when addressed by a master

ST

Structured Text – a text-oriented programming language compliant with IEC 61131-3. It is characterized by the numerous structuring possibilities of a high-level language.

TCP/IP

Transmission Control Protocol/Internet Protocol – a network protocol family. The structure of the protocol family is described in the TCP/IP reference model. TCP/IP enables data exchange beyond the borders of local networks. Neither the access to a transmission medium nor the data transmission method is defined. Ethernet is usually used in these cases.

Technology function

A ready-to-use software code for implementing machine functions quickly and reliably.





RODAVIGO, S.A.
RODAMIENTOS VIGO, S.A.

www.rodavigo.net

+34 986 288118
Servicio de Att. al Cliente

Rexroth
Bosch Group

Bosch Rexroth AG
Electric Drives and Controls
P.O. Box 13 57
97803 Lohr, Germany
Bgm.-Dr.-Nebel-Str. 2
97816 Lohr, Germany
Phone +49 9352 40-0
Fax +49 9352 40-4885
www.boschrexroth.com

Presented by



The data specified above only serve to describe the product.
As our products are constantly being further developed, no statements concerning a certain condition or suitability for a certain application can be derived from our information. The information given does not release the user from the obligation of own judgment and verification. It must be remembered that our products are subject to a natural process of wear and aging.

72 607 AE/2009-10-A1-GL
R911327801
© Bosch Rexroth AG 2009
Subject to revisions!
Printed in Germany